



Small Tool Instruments and Data Management

Form Measurement

Digital Scales and DRO Systems

Sensor Systems

Test Equipment

Optical Measurement

Vision Measuring Systems

SPRING PROMO 2026

PRECISION TOOLS & INSTRUMENTS

Effective April 1 through June 30

SPRING PROMO 2026



NEW Products **NEW FEATURED PRODUCTS**



Dear Valued Customers,

I want to thank you for your continued support of the Mitutoyo product and our team members in operations around the world. As we begin the new year, it has already proven to be a busy and exciting time for all of us at Mitutoyo America. We have worked closely with our factory and development staff to continue to expand our product lineup and overall capability with new products and enhancements to some tools that have been a part of our brand for many years.

In addition, in the United States we have continued to expand programs to provide support and resources to you, your team and the supply chain we all depend on. One example of these programs is our educational content that will help you support new employees or skill development for existing staff when new challenges are faced. You will find access to these programs from our main website (Mitutoyo.com). Look under the "Services" tab and then click on "Training & Education." While on the website, you may also look up our calibration and repair programs. You may be surprised to also find new services offered such as contract inspection and contract part programming. I hope that you explore these programs and reach out to one of the Mitutoyo Sales Representatives or valued distributor partners for more information.

The 2026 Mitutoyo Spring Promotion discounts on the most commonly used tools and instruments you will find in shops all around the country. We hope this promotion will support your needs with valuable packages and discounts.

Once again, I thank you for your continued support of Mitutoyo-made measuring solutions.

Sincerely,

Matt Dye
President, Mitutoyo America Corporation

Matthew B. Dye



TABLE OF CONTENTS

NEW Products **6 MDE QuantuMike** 6
The new MDE QuantuMike delivers faster measurements - up to 4x faster than standard micrometers - with exceptional accuracy ($\pm 1 \mu\text{m}$ permissible error), an IP65 protection rating, and a user-friendly design with enhanced display.

NEW Products **LH-600F Linear Height Gages** 10
The Mitutoyo LH-600F Linear Height Gage is the latest model in the line with several new features like an adjustable and rotatable display, intuitive touchscreen interface, and added output options for even easier, highly accurate 1D and 2D dimensional measurements.

NEW Products **ID-C/ID-F Digimatic Indicators** 14
The new Digimatic Indicators have higher resolutions down to 20 pinch/0.5 μm , a built-in calibration date warning and analog bar on the larger LCD display, and new S1 Digimatic output capabilities.

NEW Products **Profile Projectors** 22
Mitutoyo profile projectors provide some of the most accurate and clear images on the market. Easily capture accurate measurements without blurring, distortion or complex calculations using our modular 2D digital readouts.

NEW Products **QM-Fit** 24
The new QM-Fit is an all-in-one smart measurement system that delivers fast, effortless results. Automatic element detection instantly recognizes a workpiece, identifies features, and performs the measurement.

NEW Products **SurfTest SJ-220** 30
Mitutoyo surface roughness testers are highly versatile and deliver precise, accurate measurements across a wide range of applications, including portable models.

Calipers/Micrometer Heads4
Calipers/Caliper Checker5
QuantuMike/QuickMike6
Micrometers7
Tool Kits8,9
LH-600F Height Gage..... 10
QM Height Gage..... 11
Dial Indicators 12
Bore Gages12
Dial Test Indicators 13
Indicators 14,15
Specialized Indicators..... 16
Borematic 17
Holtest 18
Bluetooth® + Tool Packages20
U-WAVE Wireless Data Transmitters21
Profile Projectors22,23
QM-Fit24,25
Quick Image.....26,27
Microscopes.....28,29
SurfTest SJ-22030,31
Hardness Testers32,33
Linear Gages/EJ Counters34,35
Litematic Units with Vacuum.....36
Laser Scan Micrometers37
Linear Encoders for Lathes, Grinders, and Mills.....38
Digimatic Scales39

OUTPUT MODELS SAME PRICE AS NON-OUTPUT MODELS

Digimatic Calipers

- > AOS Electromagnetic inductive sensor improves environmental resistance against dirt, water and oil.

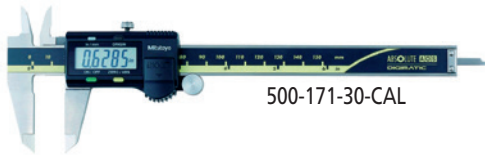

500-171-30-CAL

Coolant-Proof Calipers

- > Sealed housing is IP67 rated, meaning it's resistant to the coolants, dirt, grit and chips found in many manufacturing environments.

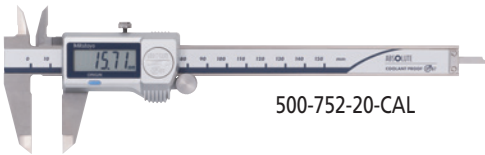

500-752-20-CAL

Dial Calipers

- > Smooth sliding with high shock protection.

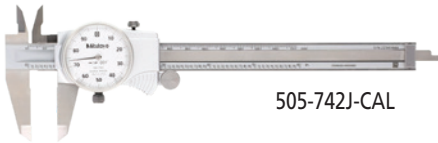

505-742J-CAL

Digimatic Micrometer

- > Range: 1"
- > Resolution: .00005" / 0.001mm
- > Features include: preset, Zero/ABS mode, Function Lock and more



293-330-30-CAL

MDC-Lite Micrometer

- > Range: 1"
- > Resolution: .00005" / 0.001mm
- > No output



293-831-30-CAL

In-Stock Calibrated Tools

Order No.	Description	List	Promo
500-195-32-CAL	Digimatic Caliper, 4"/100MM	\$223.40	\$212.23
500-196-32-CAL	Digimatic Caliper, 6"/150MM, Non-Output	\$241.55	\$222.00
500-197-32-CAL	Digimatic Caliper, 8"/200MM, Non-Output	\$337.90	\$299.00
500-193-30-CAL	Digimatic Caliper, 12"/300MM, Non-Output	\$638.05	\$599.00
500-171-32-CAL	Digimatic Caliper, 6"/150mm, SPC Output	\$276.55	\$222.00
500-172-32-CAL	Digimatic Caliper, 8"/200mm, SPC Output	\$357.80	\$299.00
500-173-30-CAL	Digimatic Caliper, 12"/300mm, SPC Output	\$736.05	\$599.00
500-505-10-CAL	Digimatic Caliper, 18"/450mm, SPC Output	\$1,119.30	\$1,063.34
500-506-10-CAL	Digimatic Caliper, 24"/600mm, SPC Output	\$1,258.40	\$1,195.48
500-752-20-CAL	Digimatic Caliper, 6"/150mm, SPC Output, IP67	\$310.55	\$295.02
500-753-20-CAL	Digimatic Caliper, 8"/200mm, SPC Output, IP67	\$408.80	\$388.36
500-754-20-CAL	Digimatic Caliper, 12"/300mm, SPC Output, IP67	\$681.05	\$647.00
505-742J-CAL	Dial Caliper, 6", .001" GRADS, .100/REV	\$203.55	\$193.37
505-743J-CAL	Dial Caliper, 8", .001" GRADS, .100/REV	\$284.80	\$270.56
505-746-CAL	Dial Caliper, 12", .001" GRADS, .100/REV	\$417.05	\$396.20
293-330-32-CAL	Digimatic Micrometer (MDC), 1", .00005" RES, SPC Output, Ratchet Stop	\$340.15	\$299.00
293-340-32-CAL	Digimatic Micrometer (MDC), 1", .00005" RES, Non-Output, Ratchet Stop	\$315.15	\$299.00
293-344-32-CAL	Digimatic Micrometer (MDC), 1", .00005" RES, Non-Output, Ratchet Thimble	\$315.15	\$299.00
293-831-32-CAL	Digimatic Micrometer (MDC-LITE), 1", .00005" RES, Ratchet Stop	\$225.15	\$213.89
293-832-32-CAL	Digimatic Micrometer (MDC-LITE), 1", .00005" RES, Friction Thimble	\$237.15	\$213.44
193-211-CAL	Digit Counter Micrometer, 1", .0001" Grads	\$271.15	\$257.59
543-702B-02-CAL	Digimatic Indicator, ID-C, .5", .00002" RES, S1 SPC Output	\$619.65	\$588.67
543-783B-12-CAL	Digimatic Indicator, ID-S, .5", .0005" RES, SPC Output	\$298.65	\$283.72
2416A-CAL	Dial Indicator (SERIES 2), 1", .001" Grads	\$200.80	\$190.76
547-500S-CAL	Digimatic Thickness Gage (ID-S TYPE), .47", .0005" RES, SPC Output	\$433.65	\$411.97

Digimatic Indicator

- > 20 µinch/0.5 µm resolution*
- > Large screen and analog bar.*
- > SPC Output

543-702B-CAL



*543-702B-CAL only

Dial Indicator

- > Improved impact- and oil-resistant materials are employed in the bezel. The improved shape of the crystal face helps with easier measurement readings.
- > Range: 1", Grads: .001"



2416A-CAL

Digit Counter Micrometer

- > Range: 1"
- > Counter Resolution: .001"
- > Vernier Graduations: .0001"

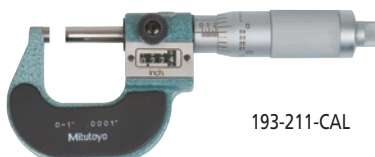

193-211-CAL

Thickness Gage

- > Range: .47"
- > Resolution: .0005"/0.01mm
- > Contacts: CERA (high wear resistance)



547-500S-CAL

OUTPUT MODELS SAME PRICE AS NON-OUTPUT MODELS

Digimatic Calipers



MeasurLink ENABLED
Data Management Software by Mitutoyo



ABSOLUTE
Model System Powered by METRO

ABSOLUTE AOS
DIGIMATIC
AOS: Advanced Onsite Sensor

- > AOS Electromagnetic Inductive Sensor improves environmental resistance against dirt, water and oil.
- > A battery life of approximately 3.5 years has been achieved under normal use through the adoption of the Mitutoyo ABSOLUTE scale.
- > The slider configuration features an ergonomic, thumb-friendly shape.
- > Step-measurement capable.
- > The data output function allows integration into Statistical Process Control and measurement systems.
- > Display character height: 9mm.
- > AOS applies to 4", 6" and 8" models.
- > Resolution: .0005"/0.01mm.

Dial Caliper

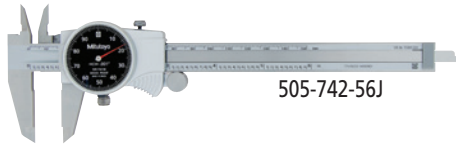

- > Smooth sliding with high shock protection.
- > Lock screw for dial bezel and for holding the sliding jaw position.
- > Can measure OD, ID, depth and steps.
- > Models available with carbide-tipped OD and ID jaws.

Order No.	Range	Remarks	List	Promo
No SPC Output Style				
500-195-32	0-4"/0-100mm	.075" Round Depth Bar	\$187.00	\$180.00
500-196-32	0-6"/0-150mm		\$202.00	\$190.00
500-197-32	0-8"/0-200mm		\$292.00	\$279.00
500-193-30	0-12"/0-300mm		\$585.00	\$550.00
With SPC Output Style				
500-170-32	0-4"/0-100mm	.075" Round Depth Bar	\$223.00	\$180.00
500-171-32	0-6"/0-150mm		\$237.00	\$190.00
500-172-32	0-8"/0-200mm		\$312.00	\$279.00
500-173-30	0-12"/0-300mm		\$683.00	\$550.00
500-505-10	0-18"/0-450mm	Without Thumb Roller	\$1,060.00	\$1,007.00
500-506-10	0-24"/0-600mm	Without Thumb Roller	\$1,170.00	\$1,111.50
500-507-10	0-40"/0-1000mm	Without Thumb Roller	\$2,260.00	\$2,147.00

ff U-WAVE-Fit compatible

SPC cable with data switch - 1m: 959149 2m: 959150

Order Numbers are subject to change, e.g. 500-196-30 will change to 500-196-32

Order No.	Range	Remarks	List	Promo
505-742J	0-6" .100"/rev		\$164.00	\$155.80
505-738	0-6" .100"/rev	Carbide-tipped jaws	\$294.00	\$279.30
505-740J	0-6" .200"/rev		\$150.00	\$142.50
505-743J	0-8" .100"/rev		\$239.00	\$227.05
505-746	0-12" .100"/rev		\$364.00	\$345.80
505-749	0-12" .200"/rev		\$340.00	\$323.00
505-742-56J	0-6" .100"/rev	Black Dial Face	\$164.00	\$155.80

Micrometer Heads

Measurement and Precision Positioning

Promo includes all models such as mechanical, Digimatic and Differential Micrometer Heads, as well as the Micro Jack and Precision Lead Screws.

UP TO 20% OFF



350-281-30



Micro Jack



MIC HEADS PROMO



Scan for Promos

Prices valid through December 15, 2026

Coolant-Proof Calipers

- > Sealed housing is IP67 rated, meaning it's resistant to coolants, dirt, grit and chips found in many manufacturing environments.
- > Easy to use - no need to wipe or clean the scale.
- > .0005"/0.01mm resolution with ± 0.001 " accuracy.
- > Automatic power On/Off.
- > Certificate of Inspection provided.

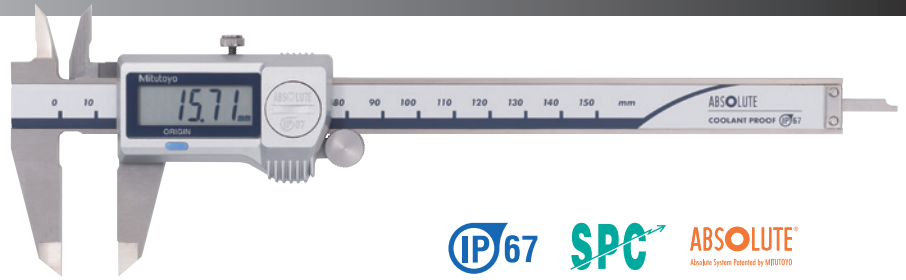

OUTPUT MODELS SAME PRICE AS NON-OUTPUT MODELS

COMPATIBLE WITH
U-WAVE fit

MeasurLink ENABLED
Data Management Software by Mitutoyo

Order No.	Range	List	Promo
Non-Output Style			
500-752-20	0-6"/0-150mm	\$271.00	\$260.00
500-753-20	0-8"/0-200mm	\$363.00	\$350.00
500-754-20*	0-12"/0-300mm	\$628.00	\$599.00
SPC Output Style			
fit 500-762-20	0-6"/0-150mm	\$321.00	\$260.00
fit 500-763-20	0-8"/0-200mm	\$405.00	\$350.00
fit 500-764-20*	0-12"/0-300mm	\$697.00	\$599.00

* ± 0.0015 " accuracy **fit** U-WAVE Fit compatible SPC cable - 1m: 05CZA624 2m: 05CZA625



COOLANT PROOF™ IP67

COOLANT PROOF is the universal term of Mitutoyo Digimatic Small Tool Instruments that are free from measurement error and physical deterioration due to routine exposure to water, cutting oil or coolant. This high performance is achieved by using encoders that are inherently immune to contamination, where exposure is inevitable, combined with comprehensive sealing techniques and extremely oil-resistant materials to guarantee a long working life under normal operating conditions.

Digimatic Carbon Fiber Caliper



MeasurLink ENABLED
Data Management Software by Mitutoyo

Order No.	Range	Accuracy	Resolution	List	Promo
552-312-10	0(.5")*-18"	+/- .002"	.0005"/0.01mm	\$1,220.00	\$1,159.00
552-313-10	0(.5")*-24"	+/- .002"	.0005"/0.01mm	\$1,380.00	\$1,311.00
552-314-10	0(1")*-40"	+/- .002"	.0005"/0.01mm	\$2,460.00	\$2,337.00
552-315-10	0(1")*-60"	+/- .004"	.0005"/0.01mm	\$2,940.00	\$2,793.00
552-316-10	0(1")*-80"	+/- .005"	.0005"/0.01mm	\$4,600.00	\$4,370.00

In parentheses = ID smallest range

SPC cable - 1m: 05CZA624 2m: 05CZA625

- > Lightweight Digimatic Calipers that employ CFRP (Carbon Fiber Reinforced Plastics) in the beam and jaws.
- > Highly durable and easy to handle.
- > Direct readout of ID measurements from the LCD. (Offset value can be set easily by pressing the Offset key.)
- > Preset function for setting a desired starting point.
- > With SPC data output.
- > Special models available with ceramic jaws which are suitable for measuring abrasive and magnetic products.
- > Can be used in workshop conditions exposed to coolant, water, dust or oil.
- > Incorporates ABSOLUTE measurement system.
- > Automatic power On/Off.



CERA Caliper Checker

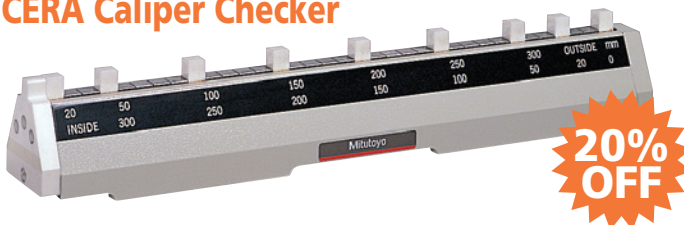

Order No.	Range	Remarks (length to check)	List	Promo
515-565	0 - 12"	Outside measurement: 1", 2", 4", 6", 8", 10", 12" Inside measurement: 1", 2", 4", 6", 8", 10", 12"	\$5,700.00	\$4,560.00

CERA Caliper Checker

- > Permanently wrung, high grade CERA gage blocks in a protective metal casing.
- > Stands perpendicular for height gage inspection.

* Also includes same features as CERA Gage Blocks

CERA (Zirconia Ceramic) Gage Blocks*

- > Extremely high wear resistance, 3x better than carbide.
- > Corrosion proof - no oil needed.
- > Closest expansion coefficient to steel.
- > Anti-magnetic - keeps away steel dust.
- > High wringing force due to high density.
- > Crack and burr resistant.
- > Low thermal conductivity - excellent dimensional stability under brief temperature changes (from handling, etc.).

QuantuMike

High-speed, high-accuracy micrometer measures 4x faster vs standard micrometers



DIGIMATIC S1



**4x Faster
1µm Accuracy**



New Features

- > Go/No-go icons: at-a-glance verification
- > Calibration date alerts: warning and due date alerts
- > Approach Speed Warning: reduce over-torquing
- > Calculation: auto-calculate corrections and more
- > S1 Digimatic output — send measurement to Excel or easily program features with software (ITPak 3.0 or MeasurLink®)
- > Auto power On/Off. Key customization

GO/NG icons



Auto-calculate

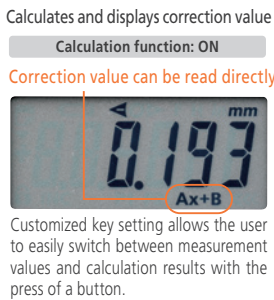

Calibration alerts

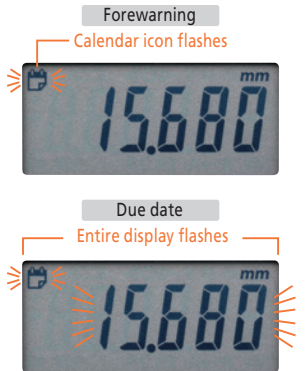

Continued Great Features

- > 4x faster spindle speed
- > Preset, Zero, Hold, Function Lock, Error display
- > 1-pc Ratchet Thimble + Speeder
- > Resolution: .00005" / 0.001mm
- > Accuracy: +/- .00005" / 0.001mm

Order No.	Description	List	Promo
293-180-40	QUANTUMIKE MICROMETER, DIGIMATIC, 0-1", IP65, .00005", W/SPC	\$358.00	\$286.40
293-181-40	QUANTUMIKE MICROMETER, DIGIMATIC, 1-2", IP65, .00005", W/SPC	\$409.00	\$327.20
293-182-40	QUANTUMIKE MICROMETER, DIGIMATIC, 2-3", IP65, .00005", W/SPC	\$487.00	\$389.60
293-183-40	QUANTUMIKE MICROMETER, DIGIMATIC, 3-4", IP65, .00005", W/SPC	\$525.00	\$420.00

QuickMikes

The updated QuickMike series still boasts the super-fast spindle feed rate that's **20x faster** than standard micrometers.

- > IP65 protection – can be used around cutting fluids.
- > MIN Hold – the minimum measurement can be held on the display for more repeatable and accurate measurements.
- > Larger LCD – 33% larger, 10mm character height.
- > Function lock – prevents accidental changes.
- > 5 year battery life – more operating time, less downtime looking for and replacing batteries.
- > Non-rotating spindle.



293-676-20

MeasurLink® ENABLED
Data Management Software by Mitutoyo

ABSOLUTE™ SPC
COOLANT PROOF™ IP65

Order No.	Range	Resolution	Accuracy	Flatness	Parallelism	List	Promo
293-676-22	0 - 1.2"	.00005"/0.001mm	±0.0001"	0.000012"	0.00008"	\$770.00	\$731.50
293-677-22	1 - 2.2"	.00005"/0.001mm	±0.0001"	0.000012"	0.00008"	\$840.00	\$798.00

Order Numbers are subject to change, e.g. 500-196-30 will change to 500-196-32

SPC cable with data switch – 1m: 05CZA662 2m: 05CZA663



Purchase the world's first 5µinch / 0.1µm resolution micrometer and receive a USB input tool and cable (nearly \$400 in value)

Using precision digital measuring tools together with a USB input tool improves both measurement results and data reliability. The high-accuracy MDH with 5 millionths resolution can output in its entirety in both inch and metric. Resulting data can input directly to Excel®, MeasurLink® or other SPC programs.

> Range: 0-1", Resolution: .000005", Accuracy: +/- .000020

Order No.	Description	List
PROMO029A	Package: MDH Mic, SPC Cable, USB Input Tool	\$2,110.00
293-130-20	MDH Micrometer with high accuracy, high resolution output	\$2,110.00
05CZA662	SPC Connecting Cable (1M)	\$144.00
264-020	USB Input Tool	\$249.00



MDC-Lite Micrometer

- > Provided with zero set and in/mm (inch/metric models only) keys.
- > A ratchet stop or friction thimble for a constant measuring force.
- > Measurement readout with large characters on the LCD.
- > No spindle clamp. No data output.

Order No.	Range	Resolution	Remarks	List	Promo
293-831-32	0 - 1" / 0 - 25.4mm	.00005" / 0.001mm	Ratchet Stop	\$196.00	\$186.20
293-832-32	0 - 1" / 0 - 25.4mm	.00005" / 0.001mm	Friction Thimble	\$208.00	\$197.60

Order Numbers are subject to change, e.g. 500-196-30 will change to 500-196-32

Digimatic Micrometer

- > New electromagnetic ABSOLUTE sensor - Improved resistance to environmental conditions such as dirt, oil and water, which can cause false readings.
- > New ratchet thimble on select models improves one-hand operability.
- > New anti-slip finish for improved grip while taking measurements.
- > Long battery life – 2.4 years under normal operation.
- > Fully compatible with existing Mitutoyo Digimatic peripherals (SPC cables, U-WAVE wireless transmitters, DP1-VA, etc.) – SPC output-enabled IP65 models.
- > Function-lock system prevents inadvertent setting changes.
- > Certificate of Inspection provided.



SPC
COOLANT PROOF™

Order No.	Range	Resolution	Remarks	List	Promo
fit 293-330-32*	0-1"/0-25.4mm	.00005"/0.001mm	Ratchet Stop	\$311.00	\$295.45
293-340-32	0-1"/0-25.4mm	.00005"/0.001mm	Ratchet Stop	\$286.00	\$271.70
293-344-32	0-1"/0-25.4mm	.00005"/0.001mm	Ratchet Thimble	\$286.00	\$271.70
293-348-32	0-1"/0-25.4mm	.00005"/0.001mm	Friction Thimble	\$286.00	\$271.70
293-349-32	0-1"/0-25.4mm	.0001"/0.001mm	Ratchet Thimble, Tenths Reading	\$286.00	\$271.70
fit 293-331-32*	1-2"/25.4-50.8mm	.00005"/0.001mm	Ratchet Stop w/Standard	\$366.00	\$347.70
293-341-32	1-2"/25.4-50.8mm	.00005"/0.001mm	Ratchet Stop w/Standard	\$315.00	\$299.25
293-345-32	1-2"/25.4-50.8mm	.00005"/0.001mm	Ratchet Thimble w/Standard	\$315.00	\$299.25
fit 293-334-32*	0-1"/0-25.4mm	.00005"/0.001mm	Ratchet Thimble	\$334.00	\$317.30
fit 293-335-32*	0-1"/0-25.4mm	.00005"/0.001mm	Friction Thimble	\$311.00	\$295.45

*with SPC Output

fit U-WAVE Fit compatible

SPC cable with data switch – 1m: 05CZA662 2m: 05CZA663

Order Numbers are subject to change, e.g. 500-196-30 will change to 500-196-32

MeasurLink ENABLED
Data Management Software by Mitutoyo



Soft Case Tool Kits

Durable Protective Cases

New protective cases for your tools offer a modern alternative to our wooden cases. Versions include mechanical, standard Digimatic, or QuantuMike-based sets. QuantuMikes are just as accurate as standard Digimatic micrometers, but up to 4x faster.

Empty cases are also available as a new home for your existing tools!



64PKA288A



RUGGED, IMPACT-RESISTANT BUILD

CASE MOULDS FOR DIGIMATIC AND MECHANICAL TOOLS

LONG-LIFE ZIPPERS AND STAIN-RESISTANT COVER

2X MAGNET-BACKED SLOTS FOR HOLDING STEEL RULES, SPANNERS, THUMB DRIVES AND MORE





64PKA283

Soft Case Tool Kit Components for 64PKA283

Order No.	Description
103-135	MIC, OUTSIDE, 0-1", 0.0001", FRICTION THIMBLE
182-204	STEEL RULE 6" 3R FLEXIBLE
505-742J	DIAL CALIPER, 6", .1"/REV
64PMT183	CASE FOR MECHANICAL TOOL KIT



64PKA284

Soft Case Tool Kit Components for 64PKA284

Order No.	Description
103-177	MIC, OUTSIDE, 0-1", 0.001", RATCHET STOP
182-102	STEEL RULE 6" 16R RIGID
505-740J	DIAL CALIPER, 6", .2"/REV
64PMT183	CASE FOR MECHANICAL TOOL KIT



64PKA285

Soft Case Tool Kit Components for 64PKA285

Order No.	Description
293-340-30	1" RATCHET STOP MICROMETER (NO SPC)
500-196-30	DIGIMATIC CALIPER, 6"/150MM, NO OUTPUT
64PMT182	CASE FOR DIGIMATIC TOOL KIT



64PKA286

Soft Case Tool Kit Components for 64PKA286

Order No.	Description
293-348-30	1" FRICTION THIMBLE MICROMETER (NO SPC)
500-196-30	DIGIMATIC CALIPER, 6"/150MM, NO OUTPUT
64PMT182	CASE FOR DIGIMATIC TOOL KIT



64PKA288A

Soft Case Tool Kit Components for 64PKA288A

Order No.	Description
293-180-40	QUANTUMIKE MICROMETER, DIGIMATIC, 0-1", IP65, .00005", W/ SPC
500-171-30	DIGIMATIC CALIPER, 6"/150MM, W/ OUTPUT
64PMT182	CASE FOR DIGIMATIC TOOL KIT

Soft Case Tool Packages

Order No.	Description	List	Promo
64PKA283	TOOL PKG, MECHANICAL, INCH, W/ 6" DIAL CALIPER, 1" OUTSIDE MIC, 6" STEEL RULE, CASE	\$404.00	\$383.80
64PKA284	TOOL PKG, MECHANICAL, INCH, W/ 6" DIAL CALIPER, 1" MIC, 6" STEEL RULE, CASE	\$349.00	\$331.55
64PKA285	TOOL PKG, DIGIMATIC, INCH, W/ 1" MIC (RATCHET STOP TYPE), 6" CALIPER, CASE	\$515.00	\$489.25
64PKA286	TOOL PKG, DIGIMATIC, INCH, W/ 1" MIC (FRICTION THIMBLE TYPE), 6" CALIPER, CASE	\$515.00	\$489.25
64PKA288A	TOOL PKG, DIGIMATIC, INCH, W/1" QUANTUMIKE, 6" CALIPER, CASE, WITH OUTPUT	\$583.00	\$553.85

Order Numbers are subject to change, e.g. 500-196-30 will change to 500-196-32

Protective Case Only

Order No.	Description	List	Promo
64PMT182	CASE FOR DIGIMATIC TOOL KIT	\$64.63	\$61.40
64PMT183	CASE FOR MECHANICAL TOOL KIT	\$66.77	\$63.43

High-Accuracy Linear Height Gage LH-600F/FG

The highest accuracy Linear Height Gage on the market is now even easier to use.

The Mitutoyo LH-600F Linear Height Measurement System is the latest model in the Mitutoyo Linear Height Gage line, designed to be more user-friendly while maintaining the best-in-class reliability and accuracy of previous models.

New Features:

- > Rotatable, adjustable touch screen interface.
- > New self-check feature.
- > High-accuracy encoder more resistant to contaminants.
- > Improved 2D mode.
- > Calibration date warning.
- > S1 Digimatic output capable of sending data directly to Excel®, wired or wirelessly.
- > Additional probe and extension options.

Still Featuring:

- > Resolution down to 0.1µinch (selectable).
- > Highest accuracy in its class $\pm (1.1+0.6L/600) \mu\text{m}$.
- > Pneumatic full/semi-float system with built-in compressor.
- > Capable of standard measurements such as heights and diameters or advanced measurements like angles, diagonal distances and perpendicularity (optional probes may be required).
- > The Origin can be set at centerline positions, peaks of radii or simply on the surface plate or gage blocks.



Power grip model also available for even easier positioning.

Perpendicular/straightness measurement - Graph creation



Show results in real time during measurement.



Show results after measurement.

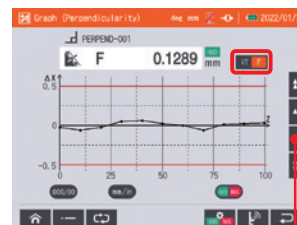

You can monitor the graphs of past measurement results.



Show measurement results in graph form.

Order No.	Description	Range (Stroke)	Resolution (selectable)	Package List	Promo
Promo030	LH-600F Inch/mm	38" (24") / 977mm (600mm)	0.0001/0.001/0.01/0.1mm .0000001/.000001/.00001/.0001"	\$11,900.00	\$10,830.00*
Promo031	LH-600FG Inch/mm, Power Grip Model			\$12,400.00	\$11,400.00*

* Promo price is 5% off of base List Price.



ABSOLUTE 1D Height Gage QM-Height Series

- > High-resolution ABSOLUTE linear encoder for position detection.
- > High-accuracy: $\pm(2.4 + 2.1L / 600)\mu\text{m}$.
- > Pneumatic flotation system / positioning grip allows for smooth movement along surface plate (select models).
- > Large, stationary display panel with user-friendly icon control keys and Go/No-go LED indicator.
- > Digital and USB output: Supports Mitutoyo wireless SPC output.
- > Fully compatible with existing Mitutoyo Digimatic peripherals (SPC cables, U-WAVE wireless transmitters, multiplexers, etc.).
- > Battery life of 1200 hours in continuous use with four AA batteries, an improvement from 300 hours.

64PKA129C

GO/±NG judgment by LED (red, orange, green) and measurement examples



d2 Digimatic and USB outputs



To install U-WAVE-T, separately purchase the optional mounting plate (02AZE990).



Order No.	Range	Resolution	Remarks	List	Promo
64PKA094C	0 - 14" / 0 - 350mm	0.001mm / 0.0005mm / .00005" / .0001" (selectable)	Pneumatic Flotation System	\$5,040.00	\$4,788.00
64PKA095C	0 - 24" / 0 - 600mm			\$5,670.00	\$5,386.50
64PKA129C	0 - 14" / 0 - 350mm			\$5,670.00	\$5,386.50
64PKA130C	0 - 24" / 0 - 600mm			\$6,280.00	\$5,966.00

ABSOLUTE Digimatic Height Gages

Popular Mitutoyo single-beam height gages have been redesigned to be even easier to use with larger displays, various hardware accessories, and multiple data options such as wired and wireless output, data loggers and more.

Features:

- > Durable Build - Iron detector and base, steel beam and holder.
- > Easy to use slider feed wheel.
- > Multiple data equipment options.
- > Other improvements: twist-off battery cap, 20% larger LCD, handy Data button.



Shown with optional Test Indicator and mounting hardware (see page 9).



Shown with optional U-Wave Bluetooth® transmitter (see page 28 and connector 02AZD790F)

MeasurLink ENABLED
Data Management Software by Mitutoyo



Order No.	Range	Resolution	Functions	Drive Method	Data Output	Max. response speed	Battery Life	List	Promo
570-412	0"-12"/0mm-300mm	0.0005" / 0/01mm	On/Off, Origin, Zero/ABS, Hold/Data, inch/mm conversion"	Slider-feed Wheel (manual)	Digimatic d1	Unlimited	Approx. 5 Years Under Normal Use	\$946.00	\$898.70
570-413	0"-18"/0mm-450mm							\$1,270.00	\$1,206.50
570-414	0"-24"/0mm-600mm							\$1,470.00	\$1,396.50

Series Two Dial Indicators

- > Improved impact, and oil-resistant materials are employed in the bezel. The improved shape of the crystal face helps with easier measurement readings.
- > High-strength, heat-treated stainless steel spindles for longevity.
- > Scratch, and chemical-resistant hard-coated crystals.
- > Increased rigidity in the bearing plate for reducing the retracing error (20%), and 4-screw mounting for greater impact resistance.
- > Inspection certificate included.
- > No through screw-holes on the frame for high oil, and dust-resistance. The bezel clamp (optional) can be attached either to the right or left side.

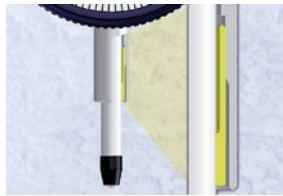

Revolutionary stem-bushing design for trouble-free stem clamping (longer clamping range; maximum tightening torque at the clamping point with M5 screw: 150N•cm).



2803A-10

2424A-19

Order No.	Graduation	Range	Range/Rev	Type	Dial Reading	Accuracy First 2.5 Rev/Overall	Force	List	Promo
2358A-10*	.0001"	.5"	.01"	w/lug	0-10	.0001 / .0008	2.0N or less	\$286.00	\$271.70
2803A-10*	.0001"	.025"	.01"	w/lug	0-5-0	.0001 / .0001	2.5N or less	\$208.00	\$197.60
2416A-10*	.001"	1"	.1"	w/lug	0-100	.001 / .002	1.8N or less	\$183.00	\$173.85
2424A-19*	.001"	2"	1"	w/lug	0-100	.001 / .003	2.5N or less	\$315.00	\$299.25
2776A	.0005"	1"	.05"	w/lug	0-50	.0005 / .002	2.5N or less	\$184.00	\$174.80

*Jeweled bearing model

Bore Gages

- > Carbide-tipped contact points for durability.
- > The dial indicator is fully protected by a rugged cover.
- > Optional extension rods can be attached for measuring deep holes.
- > The grip minimizes the variation of measurements by reducing heat transfer from the operator's hand.



511-751-20

Order No.	Range	Graduation	Anvils	Spacers	List	Promo
With Indicator						
511-751-20	.7 - 1.4"	.0001" (2923B-10)	9	2	\$535.00	\$508.25
511-752-20	1.4 - 2.5"		6	4	\$520.00	\$494.00
511-753-20	2.0 - 6.0"		11 (2" sub anvil)	4	\$569.00	\$540.55
511-754-20	4.0 - 6.5"		13	4	\$751.00	\$713.45
511-755-20	6.5 - 10"		6	7	\$848.00	\$805.60
511-756-20	10 - 16"		5 (3" sub anvil)	7	\$1,010.00	\$959.50
Without Indicator						
511-731	.7 - 1.4"	Indicator optional Protective Cover optional (21DZA000)	9	2	\$340.00	\$323.00
511-732	1.4 - 2.5"		6	4	\$348.00	\$330.60
511-733	2.0 - 6.0"		11 (2" sub anvil)	4	\$376.00	\$357.20
511-734	4.0 - 6.5"		13	4	\$562.00	\$533.90
511-735	6.5 - 10"		6	7	\$659.00	\$626.05
511-736	10 - 16"		5 (3" sub anvil)	7	\$827.00	\$785.65



See Digimatic indicators made specifically for bore gages (page 10).

Dial Test Indicators



513-404-10E
Standard

.000050" / 50μinch model now available!

- > One-piece movement assembly for improved durability & impact resistance.
- > Contact point length shown on dial face.
- > Certificate of Inspection included.
- > Shows results from both measuring directions.
- > Resilient crystal with high resistance to glare, scratches and impact.



Contact point length is printed on dial face to avoid accuracy issues

OrderNo.	Range	Graduations	Set Type	Face Color	List	Promo	Remarks
Standard							
513-407-10E	.008"	.00005"	Basic	White	\$242.00	\$229.90	Fine grads
513-407-10T	.008"	.00005"	Full	White	\$284.00	\$269.80	Fine grads
513-401-10E	.14mm	0.001mm	Basic	Yellow	\$288.00	\$273.60	
513-402-10E	.03"	.0005"	Basic	White	\$168.00	\$159.60	
513-402-10T	.03"	.0005"	Full	White	\$200.00	\$190.00	
513-403-10E	.008"	.0001"	Basic	White	\$219.00	\$208.05	
513-403-10T	.008"	.0001"	Full	White	\$257.00	\$244.15	
513-404-10E	0.8mm	0.01mm	Basic	Yellow	\$171.00	\$162.45	
513-404-10A	0.8mm	0.01mm	Plus	Yellow	\$188.00	\$178.60	
513-404-10T	0.8mm	0.01mm	Full	Yellow	\$201.00	\$190.95	
513-405-10E	0.2mm	0.002mm	Basic	Yellow	\$190.00	\$180.50	
513-405-10T	0.2mm	0.002mm	Full	Yellow	\$249.00	\$236.55	
513-406-10E	.03"/0.7mm	.0005"/0.01mm	Basic	White/Yellow	\$198.00	\$188.10	Dual dial
513-406-10T	.03"/0.7mm	.0005"/0.01mm	Full	White/Yellow	\$219.00	\$208.05	Dual dial
513-409-10E	0.2mm/.0076"	0.002mm/.0001"	Basic	Yellow/White	\$255.00	\$242.25	Dual dial
513-409-10T	0.2mm/.0076"	0.002mm/.0001"	Full	Yellow/White	\$259.00	\$246.05	Dual dial
513-412-10E	.03"	.0005"	Basic	White	\$242.00	\$229.90	
513-412-10T	.03"	.0005"	Full	White	\$279.00	\$265.05	
513-415-10E	1.0mm	0.01mm	Basic	Yellow	\$182.00	\$172.90	Long stylus
513-415-10H	1.0mm	0.01mm	Basic	Yellow	\$199.00	\$189.05	Long stylus
Ruby Tip							
513-472-10E	.03"	.0005"	Basic	White	\$188.00	\$178.60	
513-479-10E	.03"	.0005"	Basic	White	\$199.00	\$189.05	Long stylus
Standard (20° tilted face)							
513-442-10A	.06"	.0005"	Basic	White	\$229.00	\$217.55	
513-442-10T	.06"	.0005"	Full	White	\$259.00	\$246.05	
513-442-16A	.06"	.0005"	Basic	Black	\$229.00	\$217.55	
513-442-16T	.06"	.0005"	Full	Black	\$259.00	\$246.05	
513-446-16A	.06"	.0005"	Basic	Black	\$306.00	\$290.70	Long stylus
513-446-16T	.06"	.0005"	Full	Black	\$344.00	\$326.80	Long stylus
513-446-10A	.06"	.0005"	Basic	White	\$306.00	\$290.70	Long stylus
513-446-10T	.06"	.0005"	Full	White	\$344.00	\$326.80	Long stylus
513-443-10A	.016"	.0001"	Basic	White	\$288.00	\$273.60	
513-443-10T	.016"	.0001"	Full	White	\$326.00	\$309.70	
Vertical: dial is on the top of the frame							
513-452-10E	.03"	.0005"	Basic	White	\$219.00	\$208.05	
513-452-10T	.03"	.0005"	Full	White	\$242.00	\$229.90	
513-453-10E	.008"	.0001"	Basic	White	\$261.00	\$247.95	
Parallel: dial is on the side of the frame							
513-485-10E	0.2mm	0.002mm	Basic	Yellow	\$279.00	\$265.05	

Set Configuration

Inch

Full set

Swivel clamp (900322, for .157" DIA., 3/8" DIA., dovetail)

Inch holding bar (900306)

Basic set

Contact point, .079" DIA. (Carbide)

Indicator

Knurled clamp ring

Stem, .157" DIA. (21CAB106)

Stem, 3/8" DIA.

T set

E, A set

Metric

Full set

Swivel clamp (900321, for ø4mm, ø8mm, dovetail)

Metric holding bar (L: 100mm) (900209)

Plus set

Contact point, ø1mm carbide

Contact point, ø3mm carbide

Stem, ø4mm (21CAB106)

Basic set

Contact point, ø2mm (Carbide)

Indicator

Knurled clamp ring

Stem, ø8mm (Set No. 902804)

T set

A set

C set (ø 6 Stem)

E set

H set (ø 6 Stem)



SCAN ME

ID-C/ID-F Digimatic Indicators

High-performance ABS Digimatic Indicators

- > 20 μinch/0.5 μm resolution.
- > Large screen and analog bar.
- > Calibration period notification function. The LCD displays an icon to notify the user when the set calibration time approaches. This facilitates the proper precision management of ID-C/ID-F.

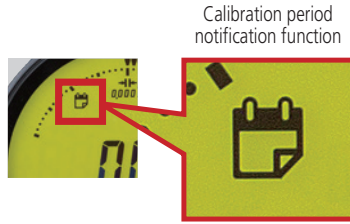

- > Simple Calculation Function.
- > New Digimatic S1 Output*. S1 is the new Mitutoyo bidirectional output format that enables reading and writing information to the gages such as sending a zero command, TIR reset, calibration date warnings, and the ability to poll the serial number for smoother measurement operation. Communication is supported by the new Input Tool and SPC cable, see table below.

Order No.	Description	List
06AGL011	SPC DIGIMATIC Cable, TYPE S1 (1M)	\$117.00
264-020	USB INPUT TOOL	\$249.00

* SPC Cable and Input Tool are both required



Excel®
Send data directly into existing forms

ITPak 3.0 Freeware
Read/Write Data and set Parameters

MeasurLink® 10.4 (see page 29)
Data Management & SPC Software



0.5" ID-F MODEL
NOW AVAILABLE



ID-C Series



ID-F Series

Large screen and analog bar

The units have large screens that can display various information in an easy-to-read manner. They also have an analog bar, convenient for observing subtle movements such as the approach to tolerance.

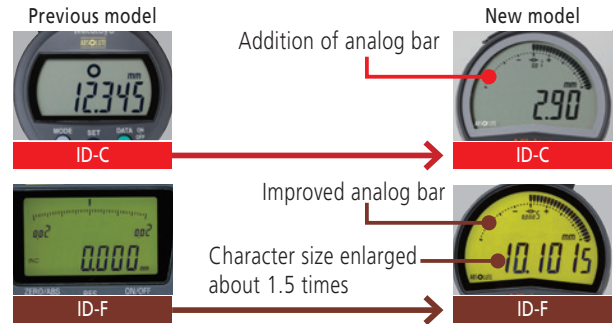

ID-C Series - Battery Operated

Order No.	With Lug	Flat Back	Range	Resolution	Maximum Permissible Error			Measuring for MPL (N)	Interface	Net mass (g)		List	Promo
					MPE _E	Hysteresis MPE _H	Repeatability MPE _R			With Lug	Flat Back		
543-702	543-702B	0.5" / 12.7mm	0.00002" / .00005" / 0.0001" / 0.0005" / 0.0005mm / 0.001mm / 0.01mm	± 0.00012" / 0.002mm	0.00008" / 0.002mm	0.00008" / 0.002mm	1.5 or less	d1/d2/S1	195	165	\$551.00	\$523.45	
543-707	543-707B	0.5" / 12.7mm					0.4 to 0.7	d1/d2/S1	190	160	\$861.00	\$817.95	
-	543-722B	1" / 25.4mm					1.8 or less	d1/d2/S1	-	195	\$710.00	\$674.50	
-	543-732B	2" / 50.8mm					2.3 or less	d1/d2/S1	-	260	\$924.00	\$877.80	
543-712	543-712B	0.5" / 12.7mm	0.0005" / 0.01mm	± 0.001" / 0.02mm	0.001" / 0.02mm	0.0005" / 0.01mm	0.9 or less	d1/S1	190	160	\$403.00	\$382.85	
543-717	543-717B	0.5" / 12.7mm					0.2 to 0.5	d1/S1	185	155	\$646.00	\$613.70	
-	543-727B	1" / 25.4mm					1.8 or less	d1/S1	-	190	\$591.00	\$561.45	
-	543-737B	2" / 50.8mm					2.3 or less	d1/S1	-	245	\$774.00	\$735.30	

Order Numbers are subject to change, e.g. 500-196-30 will change to 500-196-32

ID-F Series - AC Powered - Green/Red Backlit Display

Order No.	With Lug	Flat Back	Range	Resolution	Maximum Permissible Error			Measuring for MPL (N)	Interface	List	Promo
					MPE _E	Hysteresis MPE _H	Repeatability MPE _R				
543-856-A	543-856B-A	0.5" / 12.7mm	0.005mm / 0.001mm / 0.01 mm / 0.00002" / .00005" / 0.0001" / 0.0005"/0.001" (selectable)	± 0.0001" / 0.0025mm	0.00008" / 0.002mm	0.00008" / 0.002mm	1.5 or less	d1/d2/S1	\$743.00	\$705.85	
-	543-852A	1" / 25.4mm					1.8 or less	d1/d2/S1	\$866.00	\$822.70	
-	543-854A	2" / 50.8mm					2.3 or less	d1/d2/S1	\$983.00	\$933.85	
-	543-858A						2.3 or less	d1/d2/S1	\$1000.00	\$950.00	

Digimatic Indicator ID-H

Remote Programming Capable

- > This digital indicator offers excellent accuracy and functionality with an easy-to-read display. Take advantage of its high accuracy, backed up by 0.5µm / .00002" resolution, remote control functionality via a handheld controller (or an RS-232C interface) and easy runout measurements with the analog bar display.
- > With RS-232C input/output

- > The maximum, minimum or runout value can be displayed during measurement.
- > Go/No-go judgment is performed by setting the upper and lower tolerances. If a judgment result is out of tolerance, the display backlighting changes from green to red, so tolerance judgment can be made at a glance.

Stem dia. 3/8" #4-48 UNF Thread

Order No.	Resolution	Range	Model	Accuracy	List	Promo
543-562A	.00002", .00005", .0001", 0.0005mm, 0.001mm	1.2" / 30.4mm	ID-H530E	0.0015mm	\$1,140.00	\$1,083.00
543-564A		2.4" / 60.9mm	ID-H560E	0.0025mm	\$1,360.00	\$1,292.00

SPC cable – 1m: 936937 2m: 965014

21EZA099
Remote controller
(optional)



MeasurLink ENABLED
Data Management Software by Mitutoyo

ABSOLUTE Digimatic Indicator ID-S

- > Employing the ABSOLUTE linear encoder, the ID-S always displays the spindle ABSOLUTE Position from the origin at power-on. Also, unlimited response speed eliminates overspeed errors.
- > Dust/water protection level: IP42 (IP53: 543-796B-10).
- > SPC data output



MeasurLink ENABLED
Data Management Software by Mitutoyo



Order No.	Resolution	Range	Accuracy	Measuring force	Remarks	List	Promo
Stem dia. 3/8", #4-48 UNF Thread							
543-792-10	.00005"/0.001mm	.5" / 12.7mm	±.0001"	1.5N or less	w/ lug back	\$365.00	\$346.75
543-796-10	.00005"/0.001mm	.5" / 12.7mm	±.0001"	2.5N or less	w/ lug-back	\$403.00	\$382.85
543-793-10	.0001"/0.001mm	.5" / 12.7mm	±.0001"	1.5N or less	w/ lug back	\$354.00	\$336.30
543-783-10	.0005"/0.01mm	.5" / 12.7mm	±.0010"	1.5N or less	w/ lug-back	\$230.00	\$218.50
543-792B-10	.00005"/0.001mm	.5" / 12.7mm	±.0001"	1.5N or less	w/ flat back	\$365.00	\$346.75
543-796B-10	.00005"/0.001mm	.5" / 12.7mm	±.0001"	2.5N or less	w/ flat-back	\$403.00	\$382.85
543-793B-10	.00005"/0.001mm	.5" / 12.7mm	±.0001"	1.5N or less	w/ flat back	\$365.00	\$346.75
543-783B-10	.0005"/0.01mm	.5" / 12.7mm	±.0010"	1.5N or less	w/ flat-back	\$230.00	\$218.50

Order Numbers are subject to change, e.g. 500-196-30 will change to 500-196-32

ABSOLUTE Digimatic Indicator ID-U

- > Economical, slim digital indicator.
- > Large LCD and simple key operation.
- > Ideal for installation into measuring devices because of its compact design and long battery life.
- > Employing the ABSOLUTE linear encoder, the ID-U always displays the spindle ABSOLUTE position from the origin at power-on. Also, unlimited response speed eliminates overspeed errors.
- > Long stem for mounting.

Order No.	Resolution	Range	Model	Accuracy	Measuring force	List	Promo
575-123	.0005"/0.01mm	1" / 25.4mm	ID-U1025E	.0008"	1.8N or less	\$253.00	\$240.35

SPC cable – 1m: 905338 2m: 905409



MeasurLink ENABLED
Data Management Software by Mitutoyo

Calculation-Type Digimatic Indicator ID-C

- > Calculation-type Digimatic Indicator features both a key lock and parameter lock.
- > Fast measurement frequency up to 50 per second.
- > An analog bar provides easy-to-read values when scanning for Max, Min and TIR Values.
- > The ABSOLUTE Digimatic indicator performs internal calculations using the formula $Ax+B+Cx-1$ (assuming spindle displacement as x), while the specified coefficients A, B and C can be set with respect to the purpose of measurement or dimensions of the fixtures. This unique feature allows for reading measurements directly without searching for conversions.
- > Improved parameter setting software makes it even easier to set all of the available parameters to determine and upload the proper coefficients for calculation. (optional) 21EZA313



Custom fixture shown



543-342B-10

Order No.	Resolution	Range	Accuracy	Measuring Force	List	Promo
543-342B-10	.00005/.0001/.0005" (0.001/0.01mm) Selectable	.5"/12.7mm	±.00010"/0.003mm	1.5N or less	\$576.00	\$547.20

Stem dia. 3/8" #4-48 UNF Thread

SPC cable – 1m: 905338 2m: 905409

Bore Gage ABSOLUTE Digimatic Indicator ID-C



Installed on optional bore gage probe (page 12)

- > Hold automatically picks up hole diameter after a sweep.
- > Bore Gage Digimatic Indicator features both a key lock and parameter lock.
- > Fast measurement frequency up to 50 per second.
- > Analog bar provides easy-to-read values when scanning for Max, Min and TIR values.
- > Up to three sets of master values and upper/lower tolerance values can be stored.
- > Go/No-go judgment
- > Employing the ABSOLUTE linear encoder, the ID-C always displays the spindle ABSOLUTE Position from the origin at power-on.
- > Improved parameter setting software makes it even easier to set all of the available parameters to determine and upload the proper coefficients for calculation. (optional) 21EZA313



Order No.	Resolution	Range	Accuracy	Measuring Force	List	Promo
543-312B-10	.00005/.0001/.0005" (0.001/0.01mm) Selectable	.5"/12.7mm	±.00010"/0.003mm	1.5N or less	\$576.00	\$547.20

SPC cable – 1m: 905338 2m: 905409



543-312B-10



Peak Hold ABSOLUTE Digimatic Indicator ID-C With Max./Min. Value Holding Function

- > Peak Hold Digimatic Indicator features both a Key Lock and Parameter Lock.
- > An analog bar provides easy-to-read values when scanning for Max, Min and TIR Values.
- > Go/No-go judgment
- > The maximum, minimum or runout value can be displayed during measurement.
- > Fast measurement frequency up to 50 per second.
- > Employing the ABSOLUTE linear encoder, the Signal ID-C always displays the spindle ABSOLUTE Position from the origin at power-on.
- > Improved parameter setting software makes it even easier to set all of the available parameters and then determine and upload the proper coefficients for calculation. (optional) 21EZA313

Order No.	Resolution	Range	Accuracy	Remarks	List	Promo
Stem dia. 3/8", #4-48 UNF Thread						
543-302-10	.00005/.0001/.0005" 0.001/0.01mm	.5"/12.7mm	±.00010"/0.003mm	w/lug	\$576.00	\$547.20
543-302B-10	Selectable	.5"/12.7mm	±.00010"/0.003mm	Flat-back	\$576.00	\$547.20

SPC cable – 1m: 905338 2m: 905409



543-302B-10



Prices effective April 1 through June 30, 2026

Borematic

Quick, spring-loaded lever action/movement

- > Titanium-coated measuring pins provide excellent durability and impact resistance while allowing the instrument to measure close to the bottom of blind holes.
- > Digital display with quick-action lever operation enables quick and easy measurement.
- > Built-in ABSOLUTE System eliminates the need to set the origin point every time the unit is turned on. The system is immune to over-speed errors, thus increasing the reliability of measurement.
- > The Digimatic Borematic is compatible with statistical process control systems and measurement support systems.
- > Built-in tolerance judgment function allows Go/No-go judgment based on user-defined upper and lower limit settings.

10% OFF



MeasurLink ENABLED
Data Management Software by Mitutoyo

ABSOLUTE

SPC

Individual Gages: includes one digital display unit and one interchangeable measuring head (plus adapter if required)

Order No.	Size Range	Accuracy	Extension Rod	List	Promo
568-461	0.275" - 0.350"	±5µm ±0.00025 in	100mm (952322)	\$1,830.00	\$1,647.00
568-462	0.350" - 0.425"			\$1,660.00	\$1,494.00
568-463	0.425" - 0.500"			\$1,830.00	\$1,647.00
568-464	0.50" - 0.65"	±5µm ±0.00025 in	150mm (952621)	\$1,870.00	\$1,683.00
568-465	0.65" - 0.80"			\$1,870.00	\$1,683.00
568-466	0.8" - 1.0"			\$1,870.00	\$1,683.00
568-467	1.0" - 1.2"	±6µm ±0.0003 in	150mm (952622)	\$1,940.00	\$1,746.00
568-468	1.2" - 1.6"			\$2,130.00	\$1,917.00
568-469	1.6" - 2.0"			\$2,130.00	\$1,917.00
568-470	2.0" - 2.5"		150mm (952623)	\$2,090.00	\$1,881.00
568-471	2.5" - 3.0"			\$2,170.00	\$1,953.00
568-472	3.0" - 3.5"			\$2,200.00	\$1,980.00
568-473	3.5" - 4.0"	\$2,200.00		\$1,980.00	
568-474	4.0" - 4.5"	\$2,310.00	\$2,079.00		
568-475	4.5" - 5.0"	\$2,440.00	\$2,196.00		

Technical Data

- Resolution: 0.001mm or 0.0005in/0.001mm
- Display: LCD
- Response speed: Infinite
- Battery: SR44 (1 pc), 938882, for initial operational checks (standard accessory)
- Battery life: Approx. 5,000 hours in continuous use
- Scale type: Electrostatic capacitance ABSOLUTE encoder

Functions

Go/No-go judgment, Go/No-go judgment zoom, 2-Point preset, Zero-setting, Data hold, Error alarm, Low battery voltage alert, Data output, Function lock, 330° Rotary display, inch/mm conversion (inch/mm models)

Complete Unit Gage Sets: includes several individual gages to cover the overall size range of the set

Order No.	Overall Range	Range of Individual Gages	Setting Rings	List	Promo
568-965	0.275" - 0.5"	0.275-0.35", 0.35-0.425", 0.425-0.5"	0.35" DIA., 0.425" DIA.	\$6,330.00	\$5,697.00
568-966	0.5" - 1"	0.5-0.65", 0.65-0.8", 0.8-1"	0.65" DIA., 0.8" DIA.	\$6,590.00	\$5,931.00
568-967	1" - 2"	1-1.2", 1.2-1.6", 1.6-2"	1.2" DIA., 1.6" DIA.	\$6,890.00	\$6,201.00
568-968	2" - 3"	2-2.5", 2.5-3"	2.5" DIA.	\$4,930.00	\$4,437.00
568-969	3" - 4"	3-3.5", 3.5-4"	3.5" DIA.	\$5,470.00	\$4,923.00



Complete-Unit Set

Interchangeable-Head Sets

Order No.	Overall Range	Range of Individual Gages	Setting Rings	List	Promo
568-928	0.275" - 0.5"	0.275-0.35", 0.35-0.425", 0.425-0.5"	0.35" DIA., 0.425" DIA.	\$2,820.00	\$2,538.00
568-929	0.5" - 1"	0.5-0.65", 0.65-0.8", 0.8-1"	0.65" DIA., 0.8" DIA.	\$3,180.00	\$2,862.00
568-930	1" - 2"	1-1.2", 1.2-1.6", 1.6-2"	1.2" DIA., 1.6" DIA.	\$3,890.00	\$3,501.00
568-936	2" - 4"	2-2.5", 2.5-3", 3-3.5", 3.5-4"	2.5" DIA., 3.5" DIA.	\$5,600.00	\$5,040.00



Interchangeable-Head Set

Includes one digital display unit with several interchangeable measuring heads (and adapters as required) to cover the total size range plus one extension rod
Order Numbers are subject to change, e.g. 500-196-30 will change to 500-196-32

Digimatic Holtest

- > Titanium-coated measuring pins provide excellent durability and impact resistance while allowing the instrument to measure close to the bottom of blind holes.
- > Large LCD readout.
- > Functions available: Presetting, Zero/ABS, Auto power On/Off, Data hold, Data output, Error alarm, Battery replacement alarm.
- > With ratchet stop for consistent force.
- > Measure deep holes by attaching an extension rod (optional).
- > Setting rings are included in sets, but optional for individual gages.
- > Supplied in fitted plastic case up to 4"/100mm. Over 4"/100mm supplied in wooden case.
- > Resolution: .00005"/0.001mm (over 4" models: .0001"/0.001mm)

Digimatic Holtests – Individual Units

Order No.	Range	List	Promo
468-261	Digimatic Holtest, .275 - .35"	\$1,410.00	\$1,269.00
468-262	Digimatic Holtest, .35" - .425"	\$1,410.00	\$1,269.00
468-263	Digimatic Holtest, .425 - .5"	\$1,420.00	\$1,278.00
468-264	Digimatic Holtest, 0.5" - 0.65"	\$1,530.00	\$1,377.00
468-265	Digimatic Holtest, 0.65" - 0.8"	\$1,530.00	\$1,377.00
468-266	Digimatic Holtest, 0.8" - 1"	\$1,580.00	\$1,422.00
468-267	Digimatic Holtest, 1.0 - 1.2"	\$1,580.00	\$1,422.00
468-268	Digimatic Holtest, 1.2" - 1.6"	\$1,620.00	\$1,458.00
468-269	Digimatic Holtest, 1.6" - 2.0"	\$1,630.00	\$1,467.00
468-270	Digimatic Holtest, 2" - 2.5"	\$1,770.00	\$1,593.00
468-271	Digimatic Holtest, 2.5" - 3"	\$1,770.00	\$1,593.00
468-272	Digimatic Holtest, 3" - 3.5"	\$1,790.00	\$1,611.00
468-273	Digimatic Holtest, 3.5" - 4"	\$1,820.00	\$1,638.00
468-274	Digimatic Holtest, 4" - 5"	\$2,370.00	\$2,133.00
468-275	Digimatic Holtest, 5" - 6"	\$2,440.00	\$2,196.00
468-276	Digimatic Holtest, 6" - 7"	\$2,590.00	\$2,331.00
468-277	Digimatic Holtest, 7" - 8"	\$2,680.00	\$2,412.00
468-278	Digimatic Holtest, 8" - 9"	\$2,880.00	\$2,592.00
468-279	Digimatic Holtest, 9" - 10"	\$2,940.00	\$2,646.00
468-280	Digimatic Holtest, 10" - 11"	\$3,050.00	\$2,745.00
468-281	Digimatic Holtest, 11" - 12"	\$3,170.00	\$2,853.00

Digimatic Holtests – Interchangeable Head Sets

Order No.	Range	List	Promo
468-976	Digimatic Holtest Head Set, 0.275" - 0.5"*	\$2,560.00	\$2,304.00
468-977	Digimatic Holtest, Head Set, 0.5" - 0.8"*	\$2,080.00	\$1,872.00
468-978	Digimatic Holtest, Head Set, 0.8" - 2"*	\$5,190.00	\$4,671.00
468-979	Digimatic Holtest, Head Set, 2" - 4"*	\$5,950.00	\$5,355.00
468-980	Digimatic Holtest, Head Set, 4" - 8"*	\$6,990.00	\$6,291.00

Digimatic Holtests – Complete Unit Sets

Order No.	Range	List	Promo
468-986	Digimatic Holtest, Unit-Set, 0.275" - 0.5"*	\$4,980.00	\$4,482.00
468-987	Digimatic Holtest, Unit-Set, 0.5" - 1"*	\$5,300.00	\$4,770.00
468-988	Digimatic Holtest, Unit-Set, 1" - 2"*	\$6,010.00	\$5,409.00
468-989	Digimatic Holtest, Unit-Set, 2" - 3"*	\$6,740.00	\$6,066.00
468-990	Digimatic Holtest, Unit-Set, 3" - 4"*	\$7,930.00	\$7,137.00

Prices effective April 1 through June 30, 2026



MeasurLink[®] ENABLED
Data Management Software by Mitutoyo



Measuring Deep Holes

An extension rod (optional accessory) can be fitted to provide measurement of deep holes.

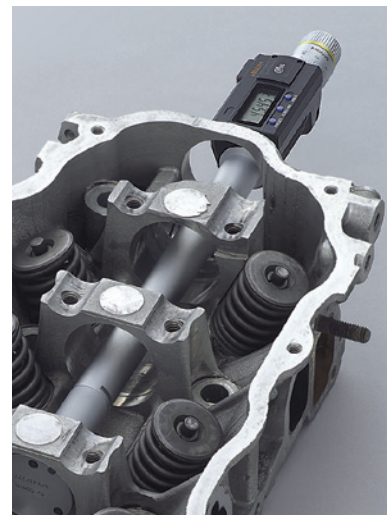

SCAN ME



Complete-Unit Set



Interchangeable-Head Set

Holtest

- ▶ Titanium-coated measuring pins provide excellent durability and impact resistance while allowing the instrument to measure close to the bottom of blind holes.
- ▶ Three-point design ensures self-centering action for stable measurements in the range above .275" bore diameter.
- ▶ With ratchet stop for consistent force.

Holtest Type II

- ▶ Holtest Type II models are also available. These lower-costs units have solid, hardened alloy steel anvils.

Mechanical Holtests – Individual Units

Order No.	Description/Range	List	Promo
368-021	Holtest, 0.08" - 0.1"	\$1,900.00	\$1,710.00
368-022	Holtest, 0.1" - 0.12"	\$1,900.00	\$1,710.00
368-023	Holtest, 0.12" - 0.16"	\$1,520.00	\$1,368.00
368-024	Holtest, 0.16" - 0.2"	\$1,520.00	\$1,368.00
368-025	Holtest, 0.2" - 0.24"	\$1,520.00	\$1,368.00
368-026	Holtest, 0.24" - 0.28"	\$1,520.00	\$1,368.00
368-261	Holtest, 0.275" - 0.35"	\$755.00	\$679.50
368-262	Holtest, 0.35" - 0.425"	\$755.00	\$679.50
368-263	Holtest, 0.425" - 0.5"	\$755.00	\$679.50
368-264	Holtest, 0.5" - 0.65"	\$783.00	\$704.70
368-265	Holtest, 0.65" - 0.8"	\$783.00	\$704.70
368-266	Holtest, 0.8" - 1.0"	\$813.00	\$731.70
368-267	Holtest, 1.0" - 1.2"	\$813.00	\$731.70
368-268	Holtest, 1.2" - 1.6"	\$1,020.00	\$918.00
368-269	Holtest, 1.6" - 2.0"	\$1,070.00	\$963.00
368-270	Holtest, 2.0" - 2.5"	\$1,080.00	\$972.00
368-271	Holtest, 2.5" - 3.0"	\$1,170.00	\$1,053.00
368-272	Holtest, 3.0" - 3.5"	\$1,200.00	\$1,080.00
368-273	Holtest, 3.5" - 4.0"	\$1,250.00	\$1,125.00
368-274	Holtest, 4.0" - 5.0"	\$1,620.00	\$1,458.00
368-275	Holtest, 5.0" - 6.0"	\$1,830.00	\$1,647.00
368-276	Holtest, 6.0" - 7.0"	\$1,880.00	\$1,692.00
368-277	Holtest, 7.0" - 8.0"	\$1,950.00	\$1,755.00
368-278	Holtest, 8.0" - 9.0"	\$2,200.00	\$1,980.00
368-279	Holtest, 9.0" - 10"	\$2,480.00	\$2,232.00
368-280	Holtest, 10" - 11"	\$2,500.00	\$2,250.00
368-281	Holtest, 11" - 12"	\$2,560.00	\$2,304.00

Mechanical Holtests – Complete Unit Sets

Order No.	Description/Range	List	Promo
368-916	Holtest, Set, 0.275" - 0.5"*	\$2,790.00	\$2,511.00
368-917	Holtest, Set, 0.5" - 0.8"*	\$1,880.00	\$1,692.00
368-918	Holtest, Set, 0.8" - 2.0"*	\$4,300.00	\$3,870.00
368-919	Holtest, Set, 2.0" - 4.0"*	\$6,120.00	\$5,508.00
368-920	Holtest, Set, 4.0" - 8.0"*	\$9,380.00	\$8,442.00
368-926	Holtest, 2pc Set, .08" - .12"*	\$4,030.00	\$3,627.00
368-927	Holtest, 4pc Set, .12" - .28"*	\$6,410.00	\$5,769.00

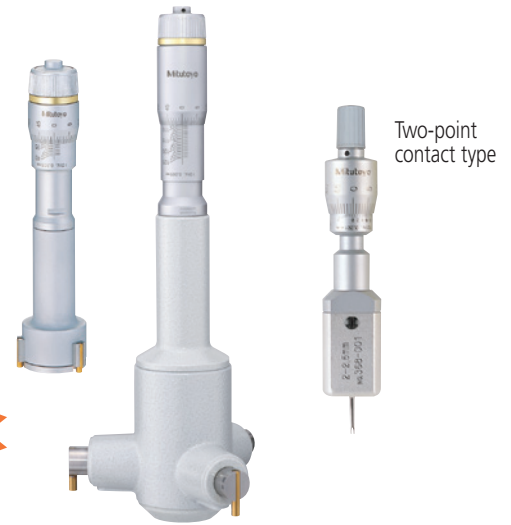

10% OFF

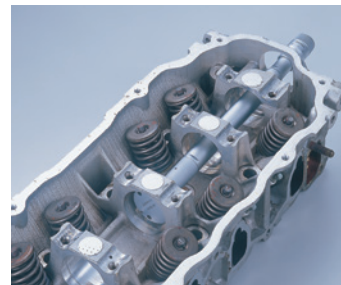

Measuring a Blind Hole

The measuring contact points held in the jaws permit measuring the diameter of a blind hole to the bottom. (up to 100mm / 4" models)

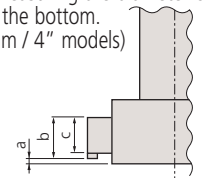

Range	a	b	c
6 - 12mm / .275 - .5"	2	—	2.5
12 - 20mm / .5 - .8"	0.3	5.6	3.5
20 - 30mm / .8 - 1.2"	0.3	8.3	5.2
30 - 50mm / 1.2 - 2"	0.3	13	10
50 - 100mm / 2 - 4"	0.3	17	14
100 - 300mm / 4 - 12"	12.4	21	13.8

Measuring Deep Holes

An extension tube (optional accessory) can be fitted to enable measurement of deep holes.



TiN coated contact points



Inspection Certificate Supplied as Standard

An Inspection Certificate is supplied with each instrument, which assures product quality and safety. On request, Mitutoyo can issue a Calibration Certificate, at a cost, from our accredited calibration laboratory.

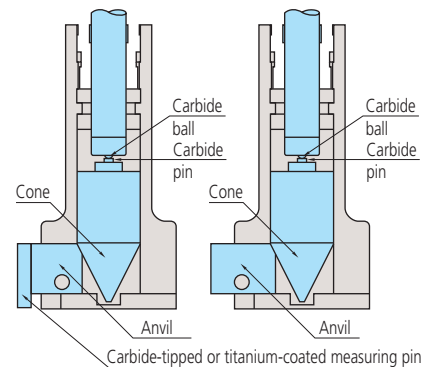

Add a Wireless Transmitter Set to your Out-Put Ready Tools to Send Data with just a Push of a Button

Now your favorite tools can be purchased in packages that include a Bluetooth transmitter and connector.

Features:

- > Send data to nearly any software.
- > Ergonomic design fits easily in the palm of your hand.
- > Up to 7 devices can be connected to 1 PC.
- > Shop-hardened, reinforced plastic housing on all models.
- > Additional dustproof/waterproof capabilities on IP67 models.
- > Up to 200,000 data transmissions with one battery.
- > Up to 16m of range.
- > Free software download on my.mitutoyo.com.



Package Components:

Digimatic Caliper package:

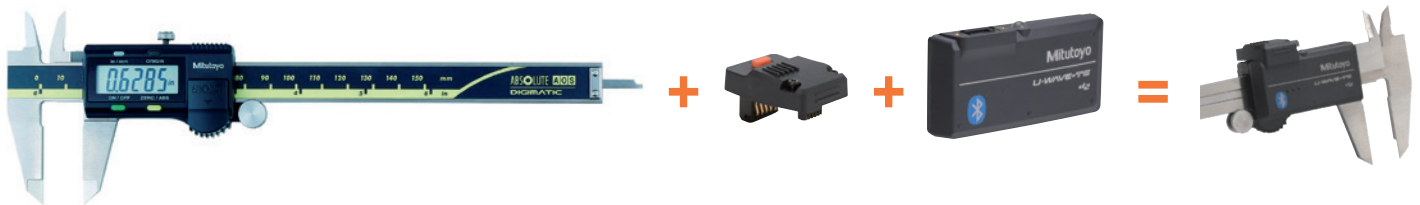

Coolant Proof Caliper package:

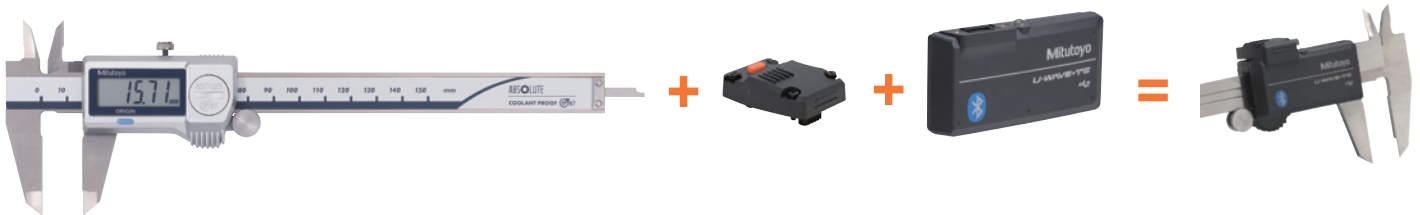

QuantuMike Micrometer package:



Order No.	Description	List	Promo
64PKA309	DIGIMATIC CALIPER, 4"/100MM, W/OUTPUT with Buzzer BT Transmitter	\$578.00	\$484.70
64PKA310	DIGIMATIC CALIPER, 6"/150MM, W/OUTPUT with Buzzer BT Transmitter	\$592.00	\$497.30
64PKA311	DIGIMATIC CALIPER, 8"/200MM, W/OUTPUT with Buzzer BT Transmitter	\$667.00	\$564.80
64PKA312	DIGIMATIC, CALIPER, 0-6", IP67, .0005"/0.01MM, W/ SPC with IP67 BT Transmitter	\$676.00	\$572.90
64PKA313	DIGIMATIC, CALIPER, 0-8", IP67, .0005"/0.01MM, W/ SPC with IP67 BT Transmitter	\$760.00	\$648.50
64PKA314	QuantuMike MICROMETER, DIGIMATIC, 0-1", IP65, .00005", W/SPC with IP67 BT Transmitter	\$696.12	\$592.70
64PKA315	QuantuMike MICROMETER, DIGIMATIC, 1-2", IP65, .00005", W/SPC with IP67 BT Transmitter	\$747.12	\$638.60
64PKA316	QuantuMike MICROMETER, DIGIMATIC, 2-3", IP65, .00005", W/SPC with IP67 BT Transmitter	\$825.12	\$708.80
64PKA317	QuantuMike MICROMETER, DIGIMATIC, 3-4", IP65, .00005", W/SPC with IP67 BT Transmitter	\$863.12	\$743.00

U-Wave Wireless

Mitutoyo original communication

(based on IEEE 802.15.4 protocol)

400,000 data transmission per battery

20m range

Up to 100 transmitters/receiver

Optional receiver (**02AZD810D**) required for Wireless packages

Gages sold separately

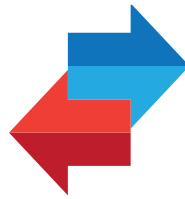

U-Wave Bluetooth

Bluetooth 4.2

communication protocol

50,000 to 200,000 data transmissions per battery

16m range

Up to 7 connections/PC

No receiver required for Bluetooth packages

Gages sold separately

U-WAVE Wireless Packages

Order Number	Description	Promo
264-622-TYPF	U-Wave Wireless Package for F-Type Indicators	\$339.20
02AZF670	U-WAVE-TM/TMB BRACKET FOR INDICATORS	
264-622	U-WAVE-TM/IP67 TYPE	
02AZD790F	U-WAVE CONNECTING CABLE F	
264-622-TYPF-FSW	U-Wave Wireless Package w/ Footswitch f or F-Type Indicators	\$489.60
02AZF670	U-WAVE-TM/TMB BRACKET FOR INDICATORS	
264-622	U-WAVE-TM/IP67 TYPE	
02AZE140F	CONNECTION CABLE TYPE F FOR FOOT SWITCH	
937179T	FOOT SWITCH	
264-622-IP-M	U-Wave Wireless Package for Micrometers	\$251.20
264-622	U-WAVE-TM/IP67 TYPE	
02AZF310	CONNECTION UNIT WATERPROOF TYPE	
264-620-IP-S	U-Wave Wireless Package for Standard Calipers	\$251.20
264-620	U-WAVE-TC/IP67 TYPE	
02AZF300	CONNECTION UNIT STANDARD TYPE	
264-620-IP	U-Wave Wireless Package for Coolant-proof Calipers	\$251.20
264-620	U-WAVE-TC/IP67 TYPE	
02AZF310	CONNECTION UNIT WATERPROOF TYPE	
02AZD730G-TYPD	U-Wave Wireless Package for SJ Units, QMH, and LSM	\$361.60
02AZD730G	U-WAVE-T/IP67 TYPE	
02AZD790D	U-WAVE CONNECTING CABLE D	
02AZE200	U-WAVE-T INSTALLATION KIT	
02AZD730G-HG	U-Wave Wireless Package for 192 and 570 Series Height Gages	\$361.60
02AZD730G	U-WAVE-T/IP67 TYPE	
02AZD790F	U-WAVE CONNECTING CABLE F	
02AZE200	U-WAVE-T INSTALLATION KIT	

U-WAVE Bluetooth® Packages

Order Number	Description	Promo
264-626-TYPF	U-Wave Bluetooth Package for F-Type Indicators	\$339.20
02AZF670	U-WAVE-TM/TMB BRACKET FOR INDICATORS	
264-626	U-WAVE-TMB/IP67 TYPE BLUETOOTH	
02AZD790F	U-WAVE CONNECTING CABLE F	
264-626-TYPF-FSW	U-Wave Bluetooth Package w/Footswitch for F-Type Indicators	\$489.60
02AZF670	U-WAVE-TM/TMB BRACKET FOR INDICATORS	
264-626	U-WAVE-TMB/IP67 TYPE BLUETOOTH	
02AZE140F	CONNECTION CABLE TYPE F FOR FOOTSWITCH	
937179T	FOOT SWITCH	
264-626-MIC	U-Wave Bluetooth Package for Micrometers	\$251.20
264-626	U-WAVE-TMB/IP67 TYPE BLUETOOTH	
02AZF310	CONNECTION UNIT WATERPROOF TYPE	
264-624-CALIPER	U-Wave Bluetooth Package for Standard Calipers	\$251.20
264-624	U-WAVE-TCB/IP67 TYPE BLUETOOTH	
02AZF300	CONNECTION UNIT STANDARD TYPE	
264-624-CALIPER67	U-Wave Bluetooth Package for Coolant-proof Calipers	\$251.20
264-624	U-WAVE-TCB/IP67 TYPE BLUETOOTH	
02AZF310	CONNECTION UNIT WATERPROOF TYPE	
264-624-TYPD	U-Wave Bluetooth Package for SJ Units, QMH, and LSM	\$301.60
264-624	U-WAVE-TCB/IP67 TYPE BLUETOOTH	
02AZD790D	U-WAVE CONNECTING CABLE D	
264-624-HG	U-Wave Bluetooth Package for 192 and 570 Series Height Gages	\$301.60
264-624	U-WAVE-TCB/IP67 TYPE BLUETOOTH	
02AZD790F	U-WAVE CONNECTING CABLE F	

Required

02AZD810D	U-Wave Wireless Receiver	\$502.40
-----------	--------------------------	----------



PH-3515F Profile Projector and 2D Processor Packages

Heavy-Duty, Bench-Top Model with Horizontal Optical System featuring display w/ M2 geometric measuring software.

- > ø14" screen, Horizontal Projector
- > 10" x 6" Travel T Slot table for accessories
- > Linear Glass Scales for accurate measurement
- > Profile and Fiber Optic Surface Illumination
- > Digital built-in angle counter
- > Maximum Load 45kg / 100lb
- > Available with M2 or QM Data 2D Processors

Order No.	Description	List	Promo
PH-3515 Main Unit & Digital Readout Packages 5% Off			
172-868-11A-KA	PH-3515F Profile Projector with KA counter & Tray	\$14,600.00	\$13,870.00
172-868-11A-QM	PH-3515F Profile Projector with QM Data & Arm Mount	\$16,900.00	\$16,055.00
172-868-11A-M2	PH-3515F Profile Projector with Touchscreen PC & M2 Software/Hardware	\$18,300.00	\$17,385.00
172-868-11A-QM-OPT	PH-3515F Profile Projector with QM Data, Arm Mount & Optoeye Edge Detection	\$19,700.00	\$18,715.00
172-868-11A-M2-EDGE	PH-3515F Profile Projector with Optical Edge Detection, Touchscreen PC & M2 Software/Hardware	\$20,000.00	\$19,000.00
Machine Stand (Optional)			
64PMI308	Machine Stand for PH Series	\$935.00	—

(Includes installation and A2LA accredited calibration)

5% OFF 5% off all Main Units



5% OFF 5% off all Packages



Installation & Calibration Included



172-868-11A-M2
PH-3515 Profile Projector, M2 Software/ Hardware and All-In-One Touchscreen PC

KA-200 Counter: PH-3515 & PV-5110

MeasurLink ENABLED
Data Management Software by Mitutoyo



Display unit for X & Y Linear Scales
> ABSOLUTE and incremental modes (10 presets each)
> 0.05-.0001mm / .02" - .000005" in resolution
> Calculator functionality

Compatible Digital-Read-Out (DRO) Devices

M2 Software & Hardware: PH-3515 & PJ-PLUS

Now offering M2 V2 with added measurement analysis capabilities.

- > 2D Coordinate Measurement Software
- > Programable Measurement Procedures
- > Statistical Analysis
- > Full integration & A2LA Calibration Included



MeasurLink ENABLED
Data Management Software by Mitutoyo

Automatic Edge Detection

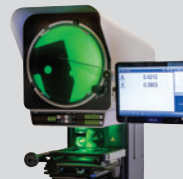

Fiber Optic Edge Detection system integrated into M2 software via M2 Communication Unit.
Intuitive Edge Teach Functionality built into software.
Allows for continuous measurement of features, while storing data for post process analysis.

PJ-Plus with M2 2D Processor Packages

The PJ-Plus is a new series of profile projectors offered by Mitutoyo. This system utilizes LED lighting and a fanless design making it ideal for harsh manufacturing facilities or job shops.

Order No.	Description	XY Stage	List	Promo
PJ-PLUS Main Units - 5% Off				
302-801-10A	PJ-P1010A 4x4"/100x100m	4x4"/100x100m	\$13,600.00	\$12,920.00
302-802-10A	PJ-P2010A 8X4"/200x200mm	8X4"/200x200mm	\$17,100.00	\$16,245.00
PJ-PLUS & M2 Packages - 5% Off				
302-801-10A-M2	PJ-PLUS 4x4 - M2 and Touchscreen PC Package	4x4"/100x100mm	\$19,000.00	\$18,050.00
302-801-10A-M2-EDGE	PJ-PLUS 4X4 - M2, Optical Edge Detection and Touchscreen	4x4"/100x100mm	\$20,600.00	\$19,570.00
302-802-10A-M2	PJ-PLUS 8x4 - M2 and Touchscreen PC Package	8x4"/200x100mm	\$22,600.00	\$21,470.00
302-802-10A-M2-EDGE	PJ-PLUS 8x4 - M2, Optical Edge Detection and Touchscreen	8x4"/200x100mm	\$24,100.00	\$22,895.00
Machine Stand (Optional)				
64PMI167	Machine Stand for PJ Series		\$867.00	—

5% OFF 5% off all Main Units



5% OFF 5% off all Packages



Installation & Calibration Included



302-801-10A-M2-EDGE

MeasurLink ENABLED
Data Management Software by Mitutoyo

An XY axis digital counter is built into the PJ-Plus



Prices effective April 1 through June 30, 2026

PV-5110 Vertical (Downward) Profile Projector (5% OFF Main Unit & 5% OFF DRO)

The PV-5110 Profile Projector is a downward optical axis projector fitted with a stable glass stage for delicate item inspection, ensuring accuracy and preventing damage. Its advanced optics and secure platform make it an optimal choice for precise applications, particularly with thin or delicate workpieces.

- > ø19.4" Screen, Vertical Projector.
- > Downward Optical Axis - Provides improved oblique surface illumination.
- > LED illumination.
- > Built-In Dual Oblique Surface Illumination for improved contrast.

Order No.	Description	List	Promo
PV-5110 Main Unit & Digital Readout Interface Packages - 5% Off			
304-919-11A-KA	PV-5110 with KA Counter	\$25,500.00	\$24,225.00
304-919-11A-QM	PV-5110 with QM Data	\$28,100.00	\$26,695.00
304-919-11A-QM-OPT	PV-5110 with QM Data and Optoeye	\$30,300.00	\$28,785.00

PLEASE NOTE: No stand or elevated surface is required.

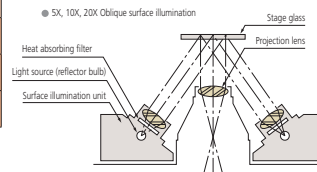

304-919-11A-KA
PV-5110 with KA Counter

- 5% OFF** 5% off all Main Units
- +**
- 5% OFF** 5% off all Packages
- +**
- Installation & Calibration Included

Additional DRO

QM Data: PH-3515, PJ-PLUS, PV-5110 & PJ-H30

The QM-Data200 unit features the powerful QM 2D coordinate measurement software pre-loaded onto our rugged user interface. The QM-Data200 interface features easy-to-use key operations and allows for measurement results to be visualized on its LCD Display.

MeasurLink[®] ENABLED
Data Management Software by Mitutoyo



Plot Single Data Points



Return 2-Dimensional Graphic and Calculated Values

- > Built-In Guided Measurement Tutorials.
- > Programmable Measurement Procedures & Calculations.
- > Data Collection and USB Output.
- > Full Integration and A2LA Calibration conducted by Mitutoyo Field Service team.

Optoeye-200

Optical Edge Detection
(Additional Purchase Required)



PJ-H30 High Accuracy Vertical Profile Projector

The Mitutoyo PJ-H30 is unique given its ability to produce an uninverted image, improving intuitive operation as the projected image appears in the same orientation as the workpiece.

- > Optical system with high NA lenses provides bright and high contrast images
- > The three-lens mounting turret includes a 10X lens as standard
- > Built-in digital XY Counter

303-716-13A &
264-131-13A-PJH-OPT



Order No.	Description	XY Travel	List	Promo
PJ-H30 Main Units - 25% OFF				
303-716-13A	PJ-H30A1010B	4x4"/100x100mm	\$29,200.00	\$27,740.00
303-717-13A	PJ-H30A2010B	8x4"/200x100mm	\$35,500.00	\$33,725.00
303-718-13A	PJ-H30A2017B	8x6.7"/200x170mm	\$42,000.00	\$39,900.00
303-719-13A	PJ-H310A3017B	12x6.7"/300x170mm	\$48,500.00	\$46,075.00
Digital Readout Interface (Add-On Packages - Optional) - 5% Off				
264-161-13A-PJH	QM-DATA200 Arm Type (PJ-H Series Package)		\$4,550.00	\$4,322.50
264-161-13A-PJH-OPT	QM-DATA200 Arm Type & Optoeye (PJ-H)		\$6,780.00	\$6,441.00
Machine Stand (Optional)				
64PMI167	Machine Stand for PJ Series		\$867.00	—

- 5% OFF** 5% off all Main Units
- +**
- 5% OFF** 5% off all Packages
- +**
- Installation & Calibration Included

MeasurLink[®] ENABLED
Data Management Software by Mitutoyo



303-717-13A PJ-H30A2010B

www.mitutoyo.com

QM-Fit

Precision at the Speed of Touch

Measure faster, easier, and anywhere with this compact desktop vision system. Just place your workpiece and instantly capture multiple dimensions with $\pm 10 \mu\text{m}$ accuracy—no focusing, no fuss. Its touch-panel control and table-top footprint make high-precision measurement simple, quick, and accurate.

- > Ideal for users of profile projectors and small measuring tools.
- > Wide field of view and spacious stage for easy workpiece setup.
- > Large batch measurement capability.
- > Operates with only a single power cord, no external PC required.
- > Automatically extracts multiple measurement elements from the image in one shot.

Order No.	Package	Description
359-752-13	359-752-13PKFS	QM-Fit with Mitutoyo Installation & Calibration
359-752-13	359-752-13PK	QM-Fit with Self Installation

Accuracy spec based on controlled environment (20 °C \pm 1 ° C)



Automatic Element Detection

Detects multiple elements at once.

Automatically recognizes and detects circles, lines, and more with just one tap. Measurements can be performed quickly without the need to specify elements one by one in advance.

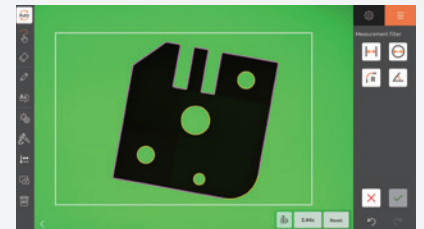

Detected elements have their outline color changed.

QM-Fit

SMART VISION SYSTEM - Compact Vision Measuring Machine

Prices effective April 1 through June 30, 2026

Place it. Measure it. Instantly.

Measuring reimaged.



Improved efficiency in measuring small objects

Advanced element recognition provides intelligent and efficient dimensional measurement. The intuitive touch panel makes accurate and reliable measurements easy for anyone to perform. Developed with our end users' requests in mind, this vision measuring system perfectly meets the needs of demanding industrial environments.

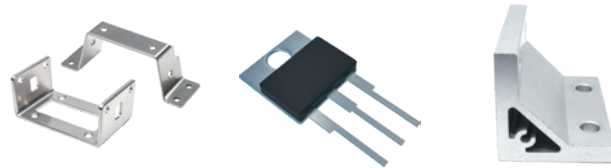

Workpieces can be measured instantly, simply by placing them on the measuring stage.

Procedure Recording

Simply place the workpiece for automatic inspection.

Even if workpieces are randomly placed on the measuring stage, it can quickly recognize their shape, identify the workpiece, and immediately begin measurement. Creating procedures is as easy as measuring a single workpiece.

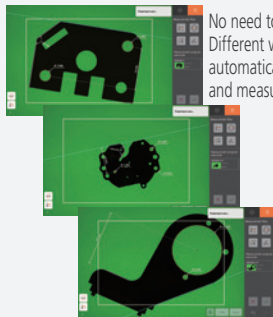

No need to push a button. Different workpieces are automatically recognized and measured.

Pass/Fail Judgment

Pass/fail checks at a glance.

By entering nominals and tolerances, the measurement results are displayed as ✓ (pass) or ✗ (fail), allowing quick judgment at a glance.

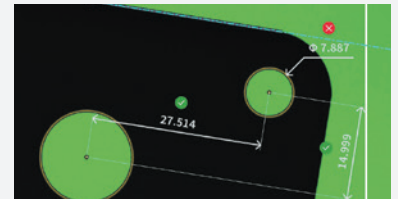

1 SMART

2 INSTINCTIVE

3 COMPACT

Quick Image

A double telecentric optical system with a large depth of focus, quick release stage, and a large selection of stage sizes make the Quick Image a high-efficiency VMM.

- > Manual or motorized stages available.
- > High pixel count color camera.
- > Automatic part location with pattern search tool.
- > CAD file overlay.
- > Profile of a line built in.
- > Stitching function allows for measurements of parts larger than the field of view.

Package	Model No.	Stage Size
361-850M3PK	QI-A1010D	4" x 4"
361-851M3PK	QI-A2010D	8" x 4"
361-852M3PK	QI-A2017D	8" x 7"
361-853M3PK	QI-A3017D	12" x 7"
361-854M3PK	QI-A4020D	16" x 8"

Packages include machine, PC, software, installation, A2A accredited calibration, and online training

 Installation & Calibration Included

+

 Online Training Course Included



M3 Software



An intuitive and thoughtful icon-driven user interface, a flexible probe library, and powerful tolerancing and programming make M3 the perfect solution for the Quick Image system.

- > Includes profile
 - Allows profile of a line comparing measured points to a nominal CAD file
- > Includes DXF overlay
 - Overlay a CAD file, similar to a profile projector overlay
- > Includes image stitching
 - Measure large parts by combining multiple fields of view into a single image
- > Includes pattern search
 - Automatically locate and measure a part regardless of size or orientation
- > Includes program finder
 - Automatically identify a part and load the corresponding part program
- > Includes multi-measure
 - Measure multiple features by drawing a box around them



Errors due to height are greatly minimized with a depth of focus up to 22mm. Measurement errors due to human focusing are eliminated.

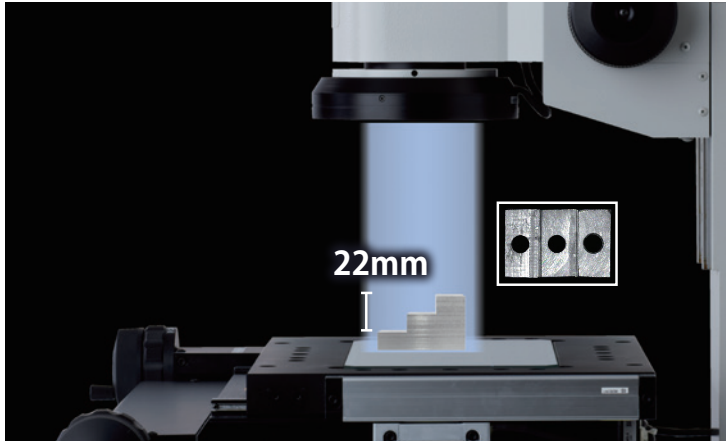

Measuring a stepped workpiece

Package	Model No.	Stage Size
361-860-11M3PK	QI-C2010D	8" x 4"
361-861-11M3PK	QI-C2017D	8" x 7"
361-862-11M3PK	QI-C3017D	12" x 7"

Packages include machine, PC, software, installation, A2A accredited calibration, and online training

Auto-Recognition

Use pattern search for multiple workpieces within the screen view, and measure them all in one operation with a single touch or mouse click. This eliminates the need for accurate positioning of workpieces and cumbersome setup of fixtures.

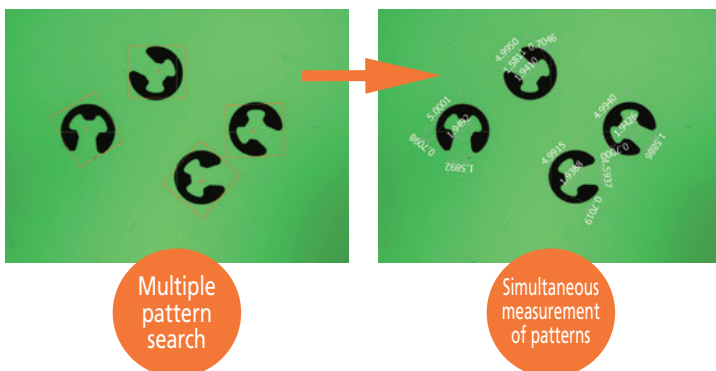

Installation & Calibration Included



Online Training Course Included



Optional Thread Module

Adds the ability to inspect external thread features and quickly calculate the Outside and Root Thread Diameters, the Pitch Diameter, the Lead, and the Root and Crest Truncation values.

Order No.	Package
64VIS002	LF-TM

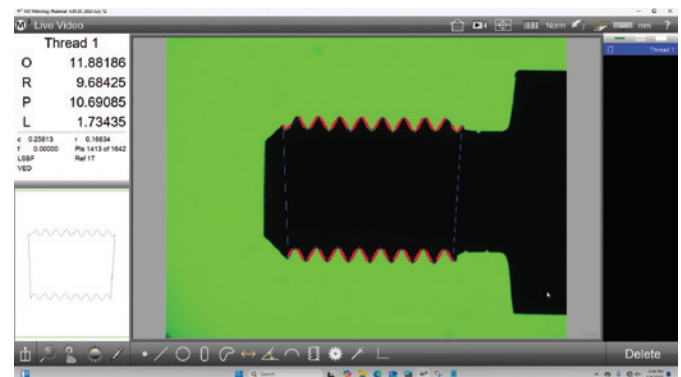

MF Measuring Microscopes with Metlogix M2 Software and Touch-Screen Tablet

Featuring M2 geometric measuring display

- > Highest measuring accuracy in its class.
- > Quick release mechanism and zero-set buttons on stage controls increase operability when working on larger workpieces.
- > Easy-to-use all-in-one PC touch screen display.
- > M2 Geometric 2D measurement software & interfacing retrofit available.
- > Camera port is standard on all models.
- > Wide range of objectives available from 1x to 100x.

MeasurLink ENABLED
Data Management Software by Mitutoyo

172-864-10 - MF-A3017, LED, BINOCULAR TUBE, 64PKA-M2-MF - M2 Software/ Hardware



MF-U Measuring Microscopes

- > Measuring accuracy that is highest in its class (and conforms to JIS B 7153).
- > Quick release mechanism and zero-set buttons on stage controls increase operability when working with large workpieces.
- > Compatible with all Mitutoyo M Plan Infinity Corrected Optics.
- > Optional manual or motorized turrets available.
- > M2 Geometric 2D measurement software & interfacing retrofit available.
- > Promoted units stage travel ranges from 200mm x 100mm to 300 x 170mm



176-878-10 MF-UB2017D - with 64PKA-M2-MF - M2 Software/ Hardware



64PKA-M2-MF M2 Retrofit Kit for MF/MF-U Microscopes

M2 is a universal 2D coordinate measurement software which has become the preferred software for many optical comparator users due to its intuitive user interface and data collection procedures.

- > Software & All-In-One Touch Screen PC Included
- > Full Integration and A2LA Calibration conducted

Discounted Microscope Main Units

LIMITED SUPPLY - WHILE SUPPLIES LAST

Order No.	Description	List	SAVINGS	Promo
176-864-10	MF-A3017D 300x170mm BrightField Manual Microscope	\$26,900.00	20%	\$21,520.00
176-878-10	MF-UB2017D 200x170mm Infinity Corrected, Bright Field, 3-Axis, Manual	\$34,900.00	20%	\$27,920.00
176-879-10	MF-UB3017D 300x170mm Infinity Corrected, Bright Field, 3-Axis, Manual	\$38,400.00	20%	\$30,720.00
176-886-10	MF-UD1010D 100x100mm Infinity Corrected, Bright Field & Dark Field, 3-Axis, Manual	\$30,400.00	20%	\$24,320.00
176-887-10	MF-UD2010D 200x100mm Infinity Corrected, Bright Field & Dark Field, 3-Axis, Manual	\$33,800.00	20%	\$27,040.00
176-888-10	MF-UD2017D 200x170mm Infinity Corrected, Bright Field & Dark Field, 3-Axis, Manual	\$37,200.00	20%	\$29,760.00
176-889-10	MF-UD3017D 300x170mm Infinity Corrected, Bright Field & Dark Field, 3-Axis, Manual	\$40,700.00	20%	\$32,560.00

*illumination Unit Sold Separately
*While Supplies Last

Installation & Calibration Included

TM Toolmakers' Microscopes

- > Adjustable illumination intensity.
- > Angle measurement is performed easily by turning the angle scale disc to align the cross-hair reticle with the workpiece image.
- > Includes standard accessories which create an overall magnification of 30X. Magnifications can be changed from 20X - 200X by using optional objectives and/or eyepieces.
- > .000050" Resolution Digimatic micrometer heads included.

MeasurLink ENABLED
Data Management Software by Mitutoyo

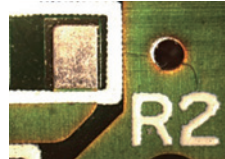

Newly designed LED illumination

5% OFF

TM-A505B
176-820-11A



Model No.	TM-A505B		TM-A1005B
Order No.	176-820-11A		176-821-11A
Eyepiece	Standard accessory: 15X (field number: 13), Options: 10X, 20X		
Objective lens	Standard accessory: 2X, Options: 5X, 10X		
Microscope head	Maximum height of workpiece	4.53" / 115mm	4.21" / 107mm
Illumination unit	Transmitted illumination	Stepless brightness adjustment, White LED light source, with green filter	
	Surface illumination	Oblique single-source type, Stepless brightness adjustment, White LED light source	
Cross-travel stage	Measuring range	2" x 2" / 50x50mm	4" x 2" / 100x50mm (An optional 2"/50mm gage block is required to cover full range. A CERA block is recommended.)
	Usable area of the stage glass	3.8" x 3.8" / 96x96mm	6" x 3.8" / 154x96mm
	Maximum stage glass loading	11 lbs. / 5kg	
Linear measurement method	Micrometer heads included		
List	\$7,050.00		\$9,190.00
Promo	\$6,697.50		\$8,730.50



Order No.	Description
64PMI247	MOTICAM S1, 1.2 MEGAPIXEL-1/3" CMOS, USB
64PMI249	MOTICAM S3, 3.0 MEGAPIXEL-1/2" CMOS, USB
64PMI248	MOTICAM S6, 6.0 MEGAPIXEL-1/1.8" CMOS, USB
64PMI252	MOTI-CAM 4000, 8 MEGAPIXEL, 1/1.8" CMOS, USB/HDMI
63AAA060	.37x C-Mount Eyetube Adapter

Trinocular Stereo Microscope SMZ143-N2LED

- > Continuous 1X - 4X magnification.
- > Image always in focus throughout zoom range.
- > Crisp, erect images with high resolution and excellent stereoscopic effect.
- > Stereo-tube can be rotated a full 360° for viewing at any angle.
- > Bilateral zoom control knob adds convenience and increases operator efficiency.
- > Diopter adjustment for both eyepieces.

Model	MSM-414TL
Order No.	377-993A
Optical tube	Trinocular head
Total magnification	10X - 40X
Eyepiece	Widefield WF10X/20mm
Objective	1X - 4X
Working distance	80mm
Field of view	20mm - 5mm
Dimensions	237x170x335mm
Mass	6.2kg

5% OFF



Order No.	Description	List	Promo
Stereo Microscope Unit			
377-993A	MSM-414TL TRINOCULAR MICROSCOPE	\$1,740.00	\$1,653.00
Observational Camera Accessories			
377-481	C-mount Video Adapter for SMZ143-N2LED	\$67.93	—
64PMI309	MOTICAM 4000X, 1.45 x 1.45µm PIXEL, HDMI / USB MULTIPOINT	\$2,420.00	—

*377-481 and 64PMI252 purchased separately



Camera with software for digital viewing

Surftest SJ-220 Packages

MeasurLink ENABLED
Data Management Software by Mitutoyo

- ▶ NEW 2.8" color touch screen makes navigation and measuring condition settings easier to perform.
- ▶ The built-in battery charges via USB Type-C has approximately 1,000 measurements on a full charge (4 hours charging time).
- ▶ Performs roughness analysis conforming to international standards JIS '82 / JIS '94 / JIS '01 / ISO '97 /ANSI/VDA including ISO21920.
- ▶ Optional MicroSD card can store up to 500 measurement conditions, 10,000 measurement results and 500 image data.
- ▶ New [HOME] key lets the operator easily recall frequently used calibration and measurement conditions.



Accessing eLearning Course after purchase:

1. Contact our Inside Sales Rep to confirm Promo Package purchased.
2. Inside Sales Rep to verify your registration on My.Mitutoyo.com
3. Inside Sales Rep then provides a code for free access.

Order No.	Seasonal Promo Price	List	Promo
178-742-13-SPP	SJ-220 4mN (STANDARD DRIVE UNIT) INCH/MM	\$3,450.00	\$2,950.00
STF-220	eLearning Course	\$40.00	Included

Order No	Calibration Package	List	Promo
178-742-13-CP	SJ-220 4mN (STANDARD DRIVE UNIT) INCH/MM	\$3,517.00	\$3,165.00
C178-602	Calibration Specimen fee	\$67.60	Included
STF-220	eLearning Course	\$40.00	Included

Order No	Data Collection Package	List	Promo
178-742-13-DC	SJ-220 4mN (STANDARD DRIVE UNIT) INCH/MM	\$3,797.00	\$3,417.00
264-628	Wireless Unit for Measuring Instrument U-WAVE-TIB	\$347.00	Included
STF-220	eLearning Course	\$40.00	Included

Order No	Height Gage Package	List	Promo
178-742-13-HG	SJ-220 4mN (STANDARD DRIVE UNIT) INCH/MM	\$4,897.00	\$4,407.00
570-413	Digimatic Height Gage (HDSH18" CX)	\$1,270.00	Included
12AAA233	Height Gage Adapter (INCH)	\$177.00	Included
STF-220	eLearning Course	\$40.00	Included

Order No	Manual Column Stand Package	List	Promo
178-742-13-MCS	SJ-220 4mN (STANDARD DRIVE UNIT) INCH/MM	\$4,968.00	\$4,471.00
178-069	Column Stand for SJ-210/220/310/410	\$1,440.00	Included
12AAA221	Magnetic Stand Adaptor (8mm DIA)	\$77.00	Included
STF-220	eLearning Course	\$40.00	Included



Calibration Certificate

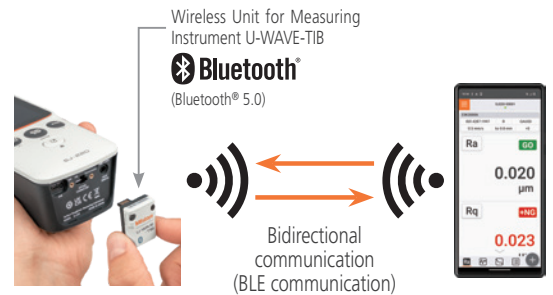

Wireless Communication System



12AAA233



12AAA233



570-413



178-069



12AAA221

This is a user-friendly device that provides compatibility and versatility to meet diverse manufacturing needs.

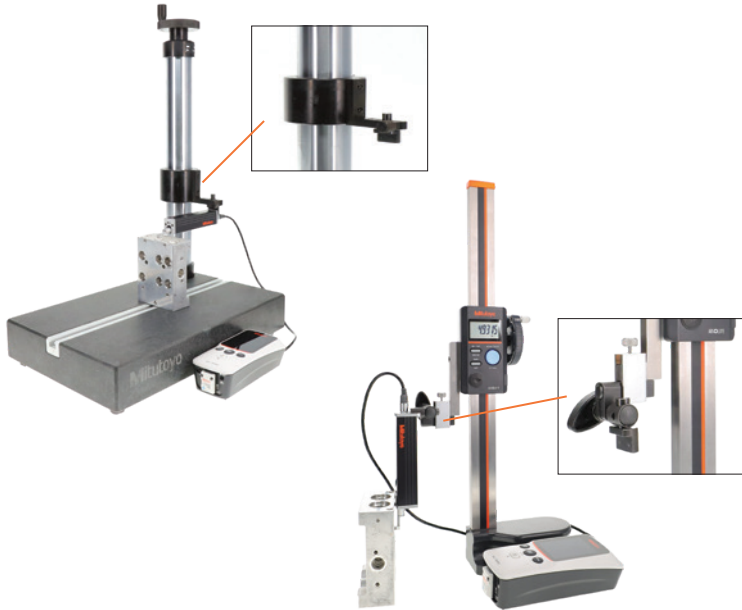

Example of combination with Height Gauge

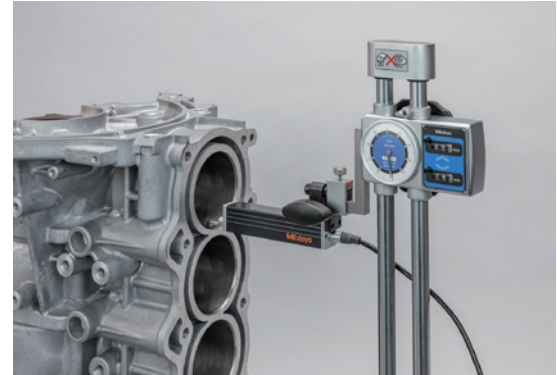

When used in combination with a Height Gauge, a variety of measurements can be performed.



Use the QR code to access a demonstration video.

Dedicated app "SJ-App" for increased efficiency of measurement work

The dedicated app that enables communication with the SJ-220 is equipped with various functions to increase work efficiency. It is also possible to manage data, create inspection reports, and export to CSV and PDF files on the terminal.

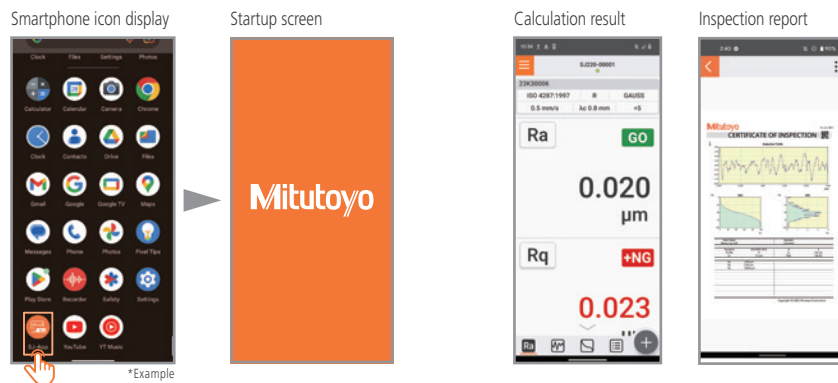

App

Dedicated smartphone app
"SJ-App"

Freely available

Can be downloaded from the Mitutoyo website.
 ■ Download site URL
<https://www2.mitutoyo.co.jp/eng/contact/products/SJ-App/>
 Android 12 or later, Bluetooth® 5.0 compatible (Android only)

Added convenience by linking to PC with highly functional free software, "SJ-Communication-Tool"

We provide free software that allows you to import various data (measurement conditions, parameter settings, calculation results, measurement data) from the SJ-220 to create and edit inspection reports on your PC. This software can significantly reduce the time it takes to create reports.

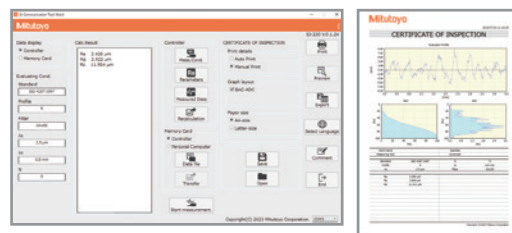

Confirmed operation environments
 ■ OS: Windows 10 (64 bit), Windows 11 (64 bit)
 * Windows is a product of Microsoft Corporation.
 * Connection requires a USB 2.0 Cable or a Wireless Unit for Measuring Instrument U-WAVE-TIB.

Software

PC-linked software
"SJ-Communication-Tool"

Freely available

Can be downloaded from the Mitutoyo website.
 ■ Download site URL
<https://www2.mitutoyo.co.jp/eng/contact/products/SJ-Communication-Tool/>
 Windows 10/11, Bluetooth® 5.0 compatible (Windows only)

Heavy Load Hardness Testers - HV Series

Highly Versatile Basic Model

HV-110/120 System A

- > Equipped with a high performance motorized test force selection function and motorized turret mounts.
- > Operates as smoothly as electric models but with the certainty of traditional test forces.
- > A list function makes it easy to perform multi-point and average hardness evaluations which required extra effort or external data processors with conventional manual models. This convenient screen enables consistency of test results.
- > Motorized test force selection and motorized turret positions can be easily controlled via a touch screen control panel. Adjustable X-Y stage with built-in digital micrometers for detailed measurement analysis.



Model	Test Force									Order No.	Body	List	Promo
HV-110	V.S*	HV1	HV2	HV3	HV4	HV5	HV10	HV20	HV50	810-441A	HV-110 - TYPE A - MANUAL BODY IN/MM SPECIFICATION	\$26,531.25	\$21,225.00
	N	9.807	19.61	29.52	49.03	98.07	196.10	294.2	490.3				
	kgf	1	2	3	5	10	20	30	50				
HV-120	V.S*	HV 0.3	HV 0.5	HV1	HV2.5	HV5	HV10	HV20	HV30	810-446A	HV-120 - TYPE A - MANUAL BODY IN/MM SPECIFICATION	\$26,531.25	\$21,225.00
	N	2.942	4.903	9.807	24.51	49.03	98.07	196.1	294.2				
	kgf	0.3	0.5	1	2.5	5	10	20	30				

*V.S - Vickers Scale

*Additional Components Required for a Complete System

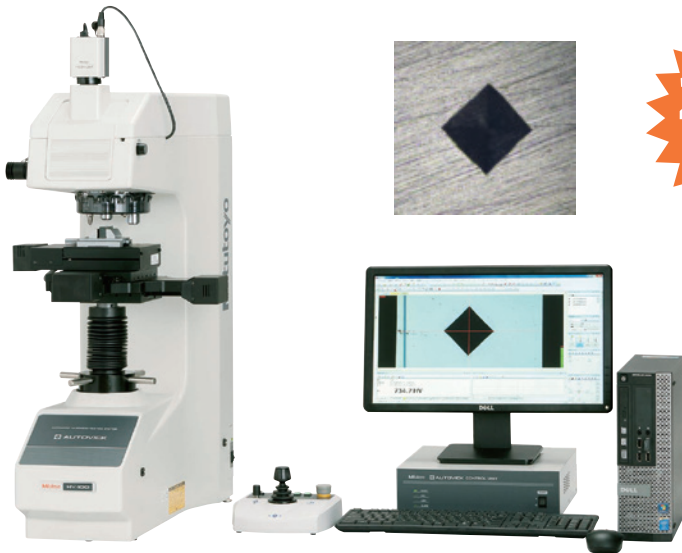

Installation & Calibration
Included

HV-110/120 System B,D

- > B and D series testers feature AVPAK dedicated image software enabling automatic indentation reading with excellent automatic edge detection capability, reducing reading variation and visual error.
- > D series testers add powered X-Y stages which enable automatic continuous testing. This allows extended multi-point testing, complex pattern creation and multiple workpiece analysis to be carried out automatically.
- > D series testers add Auto Focus and create a fully automatic system that dramatically shortens the cycle time of your test and indentation analysis.

Model	Test Force									Order No.	Body	List	Promo
HV-110	V.S*	HV1	HV2	HV3	HV4	HV5	HV10	HV20	HV50	810-443A	HV-110 - TYPE B/D - BODY IN/MM SPECIFICATION	\$35,062.50	\$28,050.00
	N	9.807	19.61	29.52	49.03	98.07	196.10	294.2	490.3				
	kgf	1	2	3	5	10	20	30	50				
HV-120	V.S*	HV 0.3	HV 0.5	HV1	HV2.5	HV5	HV10	HV20	HV30	810-448A	HV-120 - TYPE B/D - BODY IN/MM SPECIFICATION	\$35,062.50	\$28,050.00
	N	2.942	4.903	9.807	24.51	49.03	98.07	196.1	294.2				
	kgf	0.3	0.5	1	2.5	5	10	20	30				

*V.S - Vickers Scale

*Additional Components Required for a Complete System



Micro Vickers Hardness Testers - HM Series

- > HM Type A systems include a built-in measuring eyepiece for indentation analysis and accurate workpiece positioning.
- > Automatic Turret (Touch-screen controlled in Type A systems and software controlled via AVPAK in Type B and D systems).
- > Test force range 10g-1000g (HM-210) and .05-2000g (HM-220).
- > LED illumination.
- > Type B and D systems include a camera for software analysis (Type A systems can use optional camera for digital imagery).
- > Type A and B systems use micrometer-controlled adjustable stages and Type D systems utilize a motorized XY Stage.



64AAB308PA
HM-210B Type System



Installation & Calibration Included

20% OFF MICRO VICKERS TESTERS!

MeasurLink ENABLED
Data Management Software by Mitutoyo

Functions	System A	System B	System D
Focusing	Manual	Manual	Automatic
Testing Action	Single Point	Single Point	Pattern Specific
Test-point Positioning	Manual X-Y Stage	Manual X-Y Stage	Automatic X-Y Stage
Measuring Indentations	Manual Monoscope	Automatic by AVPAK	Automatic by AVPAK
Camera (for observing and measuring indentations)	600,000 Pixels B&W*	Color, 3 Million Pixels	Color, 3 Million Pixels
Operating the Main Unit	Touch Panel	PC**	PC**



*PC Sold Separately

** PC sold separately

*Additional packages available. Please contact your local Mitutoyo distributor or Mitutoyo sales representative.

Discounted Testers

Order No.	Description	List	SAVINGS	Promo
64AAB307P	HM220 VICKERS HARDNESS TESTER, TYPE A	\$30,600.00	\$6,120.00	\$24,480.00
64AAB308P	HM220 VICKERS & KNOOP HARDNESS TESTER, TYPE A	\$39,500.00	\$7,900.00	\$31,600.00
64AAB323PA	HM-210 VICKERS HARDNESS TESTER, TYPE B	\$44,100.00	\$8,820.00	\$35,280.00
64AAB324PA	HM-210 VICKERS & KNOOP HARDNESS TESTER, TYPE B	\$51,600.00	\$10,320.00	\$41,280.00
64AAB325P	HM-220 VICKERS HARDNESS TESTER, TYPE B	\$47,500.00	\$9,500.00	\$38,000.00
64AAB326P	HM-220 VICKERS & KNOOP HARDNESS TESTER, TYPE B	\$56,900.00	\$11,380.00	\$45,520.00
64AAB380PA	HM-210 VICKERS HARDNESS TESTER, TYPE D	\$72,200.00	\$14,440.00	\$57,760.00
64AAB381PA	HM-210 VICKERS & KNOOP HARDNESS TESTER, TYPE D	\$79,700.00	\$15,940.00	\$63,760.00
64AAB382P	HM-220 VICKERS HARDNESS TESTER, TYPE D	\$75,600.00	\$15,120.00	\$60,480.00
64AAB383P	HM-220 VICKERS & KNOOP HARDNESS TESTER, TYPE D	\$84,000.00	\$16,800.00	\$67,200.00

EJ Series Industrial Interface-mounted Compact Counter

Counter unit
EJ-102N



CC-Link



PROFINET



Interface unit
EtherNet/IP



EtherCAT



USB



Compact size and easy to use

Up to 8 compact counters (EJ counters) can be linked providing the capacity to connect up to 16 gages. On a DIN rail, each unit can be connected directly without using cables, so it takes up minimal space. All linked units and gages can be driven by a single power source.

EtherNet/IP, CC-Link, PROFINET, EtherCAT or USB Connection

Data can be output through an industrial interface by linking a compact counter (EJ counter) with an interface unit. Constant data monitoring and positional management are performed. A USB interface is also provided for easy connection with a computer.

Note: The range of interfaces is set to be expanded in the near future.

Order No.	Description	List	Promo
542-081	Main EJ Module Counter	\$818.00	\$777.10
542-081A	Main EJ Module w/AC Components	\$1,150.00	\$1,092.50
21HZA149	USB Only Interface	\$600.00	\$570.00
21HZA186	CC-Link Module (Mitsubishi), and USB	\$1,330.00	\$1,263.50
21HZA187	PROFINET Module	\$1,330.00	\$1,263.50
21HZA188	EtherNet/IP Module	\$1,380.00	\$1,311.00
21HZA264	EtherCat Module	\$1,330.00	\$1,263.50

Calculation function

Enables sum difference operations between 2 gages connected to the same counter. Functions such as tolerance judgment and peak hold are also included.

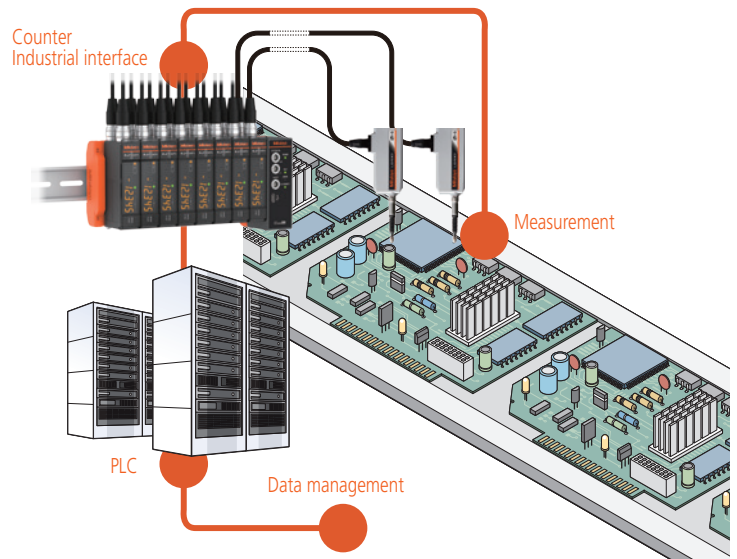

Linear Gage LG200 Series

- > Slimmer body with approx. 1/5 cross section compared with 542-190 (LG100).
- > High-accuracy gage head suitable for in-line and in-laboratory use.
- > Assures the expected repeatability (2σ) in the full measurement range and the narrow-range precision.
- > Protection grade IP67G with sliding durability of 100 million times and more and adoption of highly oil-resistant materials.
- > It can be connected to a compact counter (EJ counter) suitable for in-line use or building into a device or a multifunctional counter (EH counter) suitable for use in measurement rooms.



542-186/542-187/542-188

Order No.	Description	List	Promo
542-186	LG200-110, Range: 0.4"/10mm, Res.:0.0005"/1μm	\$1,050.00	\$997.50
542-187	LG200-0510, Range: 0.4"/10mm, Res.:0.0002"/0.5μm	\$1,130.00	\$1,073.50
542-188	LG200-0110, Range: 0.4"/10mm, Res.:0.0005"/0.1μm	\$1,210.00	\$1,149.50

Linear Gage LG100 Series

High Accuracy

Precision and accuracy demanded by the automated assembly and inspection markets are guaranteed. Due to our expertise as a manufacturer of measuring instruments, repeatability in the full measurement range (2σ) and narrow-range precision are also guaranteed.

Environment Resistance

Sliding durability of more than 50 million cycles*, with protection level of IP67G. A highly oil-resistant material is used in the rubber cap and cable sheath so it can be used in harsh environments.

* 10 mm range models (Actual value from in-house tests)

Reference Point Detection (LG100 Series)

Reference point signal output functions are featured throughout this series. When incorporating into a device, the master setting value is easy to set and is retained after shutdown.



Order No.	Description	List	Promo
542-190	LG100-110, Range: .4"/10mm, Res: .00005"/1μm	\$906.00	\$860.70
542-191	LG100-0510, Range: .4"/10mm, Res: .00002"/0.5μm	\$1,030.00	\$978.50
542-192	LG100-0110, Range: .4"/10mm, Res: 5μinch/0.1μm	\$1,120.00	\$1,064.00
542-193	LG100-125, Range: 1"/25mm, Res: .00005"/1μm	\$1,150.00	\$1,092.50
542-194	LG100-0525, Range: 1"/25mm, Res: .00002"/0.5μm	\$1,290.00	\$1,225.50
542-195	LG100-0125, Range: 1"/25mm, Res: 5μinch/0.1μm	\$1,380.00	\$1,311.00
542-196	LG100-150, Range: 2"/50mm, Res: .00005"/1μm	\$1,400.00	\$1,330.00
542-197	LG100-0550, Range: 2"/50mm, Res: .00002"/0.5μm	\$1,550.00	\$1,472.50

LG QuickSetup Tool

A configuration tool is FREE for use with the EJ counter when connected via the optional USB interface. Multiple settings normally carried out with counter operating keys can now be easily applied from a computer. Live displays allow for easily viewing gage positions or measurements at a glance.

Note: This software can be used free of charge and downloaded from the Mitutoyo website.
<https://www.mitutoyo.co.jp/eng/contact/products/lg/>

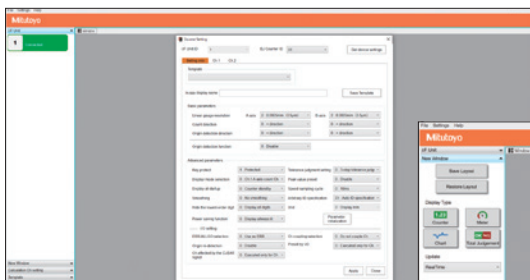

Parameter setting



Chart



General settings

Solution for Battery Foil Thickness Measurement

The key to success:

High accuracy thickness measurement of thin foil and film samples.

- > The combination of the Litematic and the vacuum plate system provides high accuracy measurement of easily deformed material.
- > Litematics allow measurements at forces as low as 0.01N. The ceramic ball contact included with the Vacuum Packages will increase the force to 0.04N.
- > The vacuum plate absorbs the contact-sensitive specimen, such as battery film, onto the plate surface for more stable measurement.
- > Mitutoyo America provides vacuum plate packages as well as custom-made solutions.
- > Optional set 02AZE375 enables the application of up to 10 intermediate forces.
- > Data export to MeasurLink® and MS Excel®.

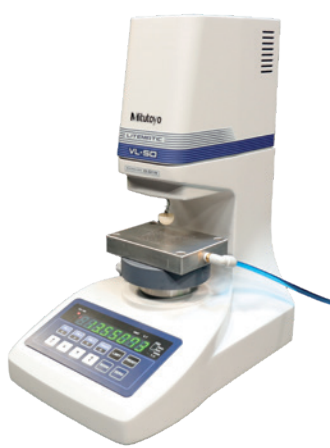
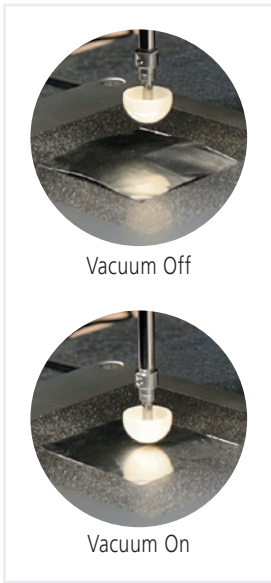
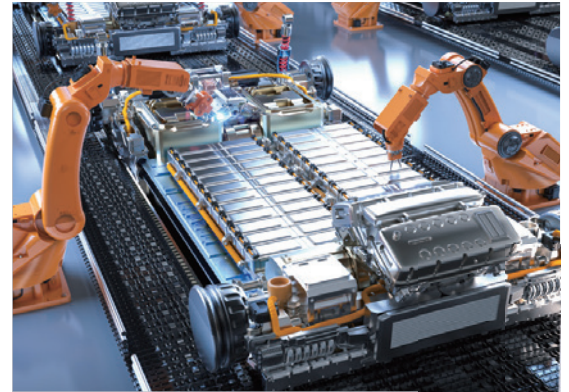

318-221A + 64PKA297



318-221A + K543722



318-226A + 64PKA298 + 957460



Stand-alone Litematic Main Unit

Order No.	Model	Test Force*	List	Promo
318-221-10A	VL-50-B	0.01N	\$10,700.00	\$10,165.00

- > Measuring accuracy (20°C) up to $(0.5+L/100) \mu\text{m}$
L=arbitrary measuring length (mm).
- > Repeatability up to 0.05 μm .



Vacuum Package Add-ons

Order No.	Model	List	Promo
64PKA297	50x50mm Vacuum Package	\$4,730.00	\$4,635.40
K543722	Laser-activated Vacuum Package	\$10,300.00	\$10,042.50

*The ceramic ball contact included with Vacuum Packages will add 0.03N.



Separate Type Litematic Main Unit

Order No.	Model	Test Force*	List	Promo
318-226A	VL-50S-B	0.01N	\$10,700.00	\$10,165.00
957460	Granite Stand		\$7,520.00	\$7,144.00

- > Measuring accuracy (20°C) up to $(0.5+L/100) \mu\text{m}$
L=arbitrary measuring length (mm).
- > Repeatability up to 0.05 μm .



Vacuum Package Add-ons

Order No.	Model	List	Promo
64PKA298	100x100mm Vacuum Package	\$5,870.00	\$5,752.60

*The ceramic ball contact included with Vacuum Packages will add 0.03N.

Ultra-High Accuracy

Laser Scan Micrometer LSM-6902H

MeasurLink ENABLED
Data Management Software by Mitutoyo

- > Improved narrow range repeatability of 0.03µm / 1.2µin
- > The best repeatability available in the 25mm/1" class.
- > The ultra-precise scanning motor enables the highest measurement accuracy.
- > Thanks to excellent linearity, an accuracy of ±0.5µm over the entire measuring range and a higher accuracy of ±(0.3+0.1ΔD)µm over a narrow range are guaranteed.
- > An excellent option for measuring pin gages or plug gages.



544-499A



Order No	Range	Resolution	List	Promo
544-499-1A	.004" - 1.0"/0.1mm - 25mm	.000001" - .0005"/0.00001 - 0.01mm	\$13,900.00	\$13,205.00

QUICKTOOL* is free downloadable software that makes programming the LSM-6200 quick and easy.

*For use with customer-supplied PC and optional RS-232C cable.

High-Accuracy Non-Contact Measuring Systems

- > Excellent linearity: down to +/- 0.3 micron.
- > High-speed scanning capable: 3,200 scans per second.
- > Various ranges available for selecting the best laser for your application.
- > Statistical calculation mode.
- > Memory function has been increased to allow storage of up to 100 programs.

QUICKTOOL* is free downloadable software that makes programming the LSM-6200 quick and easy.

*For use with customer-supplied PC and optional RS-232C cable.

Package



LSM-6200 Display Unit Included

MeasurLink ENABLED
Data Management Software by Mitutoyo

WHILE SUPPLIES LAST

Order No	Model	Range Inch	Range mm	Repeatability	Linearity	Scanning Rate	List	Promo
64PKA117	LSM-500S	.0002" - .08"	0.005~2mm	±0.03µm	±0.3µm	3,200 scans/sec	\$13,100.00	\$12,445.00
64PKA118	LSM-501S	.002" - .4"	0.05~10mm	±0.04µm	±0.5µm [†]	3,200 scans/sec	\$11,800.00	\$11,210.00
64PKA119	LSM-503S	.012" - 1.18"	0.3~30mm	±0.11µm	±1.0µm [†]	3,200 scans/sec	\$12,800.00	\$12,160.00
64PKA120	LSM-506S	.04" - 2.36"	1~60mm	±0.36µm	±3µm [†]	3,200 scans/sec	\$14,500.00	\$13,775.00
64PKA121	LSM-512S	.04" - 4.72"	1~120mm	±0.85µm	±6µm [†]	3,200 scans/sec	\$22,300.00	\$21,185.00

[†] Linearity over entire range. Higher accuracies are possible over smaller ranges.

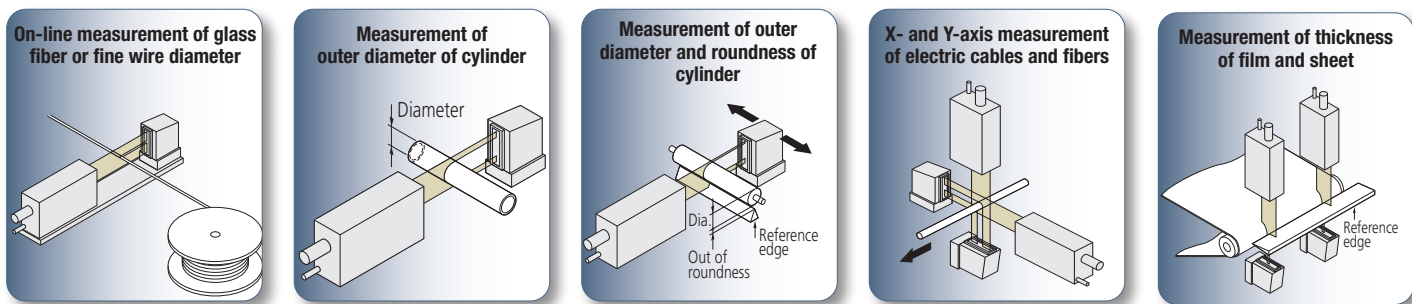

Mitutoyo Digital Readout Packages

Mounting hardware included on all machine retrofit packages

SAVE UP TO
\$200
PER PACKAGE



All DRO Packages Include:

- > KA-200 Counter
- > KA-200 Counter tray/arm kit
- > High Resolution Linear Scales (down to .0001" or better!)
- > Bracket Kit(s)

Package Order No.	Description	X Travel	Y Travel	Z Travel	X Axis Type	Y Axis Type	Z Axis Type	List	Promo
64PKA058D	12" X 30" DRO Mill Package	30"	12"	-	AT715	AT715	-	\$2,570.00	\$2,441.50
64PKA059D	12" X 36" DRO Mill Package	36"	12"	-	AT715	AT715	-	\$2,570.00	\$2,441.50
64PKA060D	14" X 30" DRO Mill Package	30"	14"	-	AT715	AT715	-	\$2,570.00	\$2,441.50
64PKA175B	16" X 30" DRO Mill Package	30"	16"	-	AT715	AT715	-	\$2,570.00	\$2,441.50
64PKA062D	16" X 36" DRO Mill Package	36"	16"	-	AT715	AT715	-	\$2,570.00	\$2,441.50
64PKA063C	16" X 40" DRO Mill Package	40"	16"	-	AT715	AT715	-	\$2,570.00	\$2,441.50
64PKA039C	8" X 40" Lathe Package	8"	-	40"	AT113	-	AT715	\$2,960.00	\$2,812.00
64PKA194B	8" X 36" Lathe Package	8"	-	36"	AT113	-	AT715	\$2,910.00	\$2,764.50
64PKA054B	48" X 14" Lathe Package	14"	-	48"	AT116	-	AT715	\$2,990.00	\$2,840.50
64PKA052C	14" X 40" Lathe Package	14"	-	40"	AT116	-	AT715	\$2,990.00	\$2,840.50
64PKA057C	16" X 60" Lathe Package	16"	-	60"	AT116	-	AT715	\$3,320.00	\$3,154.00
64PKA028C	8" X 12" Grinder Package	8"	12"	-	AT113	AT113	-	\$3,700.00	\$3,515.00
64PKA029B	8" X 14" Grinder Package	12"	14"	-	AT113	AT113	-	\$3,700.00	\$3,515.00

Other packages and kits are available for mills, lathes, grinders and custom machines and applications. Contact your local distributor for details.

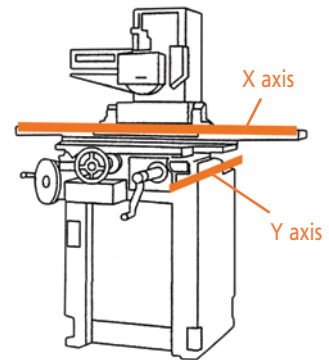
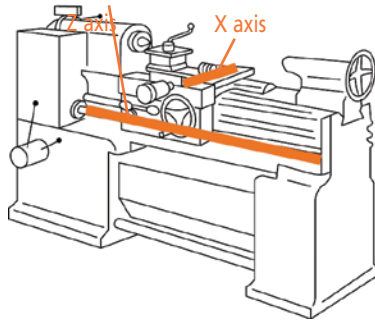
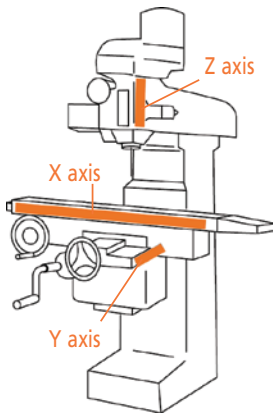

Digimatic Quill Kit

Easy Installation, Fits Most Vertical Knee Mills

- > Easy-to-read LCD with resolution of .0005"/0.01mm. 0-6" travel.
- > Push-button controls for inch/mm, Zero-Set and On/Off.
- > Powered by a single SR-44 Battery which lasts about 1 year with normal use.
- > SPC Output for data transmission to data processors or a remote display.
- > ABS encoder.

Order No.	Description	List	Promo
053906B	Digimatic Quill Kit Complete with Brackets & Scale for Bridgeport Type Machines	\$534.00	\$507.30

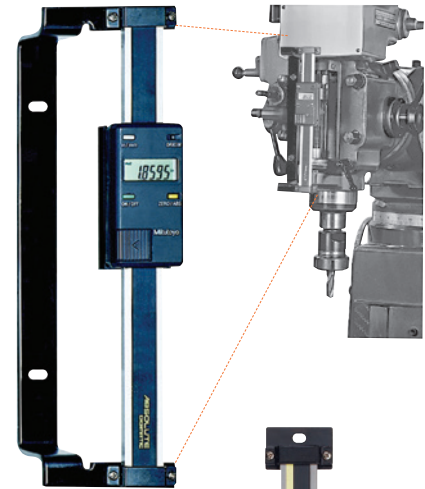

ABSOLUTE Digimatic Scale Units

- > The Origin key allows setting of an ABSOLUTE zero point to be used as reference in subsequent measurements. Once set, the ABS Digimatic Scale Unit is ready to show its true position whenever turned on, rather than 0.00" as with standard models.
- > The Zero/ABS key allows the display to be zero-set at any slider position along the beam for incremental comparison measurements. This key will also allow return to the ABSOLUTE coordinate with a display of the true position from the origin point.
- > No rack, no pinion, no glass scale. Digimatic scale unit is safely embedded in the hardened stainless steel blade.
- > Horizontal or vertical face according to the scale mounting direction.
- > Multi-function types with diameter displaying function are also available for lathes. (Contact Mitutoyo.)
- > All units come with two mounting brackets, each located at either end of the scale.
- > With SPC data output.



Order No.	Model	Range	Accuracy	Resolution	Type	List	Promo
572-210-30	SD-4"DX	0-4" / 0-100mm	.001" / 0.03mm	.0005" / 0.01mm	Horizontal Single-function	\$404.00	\$363.60
572-211-30	SD-6"DX	0-6" / 0-150mm	.001" / 0.03mm	.0005" / 0.01mm	Horizontal Single-function	\$428.00	\$385.20
572-212-30	SD-8"DX	0-8" / 0-200mm	.001" / 0.03mm	.0005" / 0.01mm	Horizontal Single-function	\$498.00	\$448.20
572-213-10	SD-12"D	0-12" / 0-300mm	.002" / 0.04mm	.0005" / 0.01mm	Horizontal Single-function	\$962.00	\$865.80
572-310-10	SDV-6"D	0-4" / 0-100mm	.001" / 0.03mm	.0005" / 0.01mm	Vertical Single-function	\$447.00	\$402.30
572-311-10	SDV-6"D	0-6" / 0-150mm	.001" / 0.03mm	.0005" / 0.01mm	Vertical Single-function	\$474.00	\$426.60
572-312-10	SDV-8"D	0-8" / 0-200mm	.001" / 0.03mm	.0005" / 0.01mm	Vertical Single-function	\$551.00	\$495.90
572-313-10	SDV-12"D	0-12" / 0-300mm	.002" / 0.04mm	.0005" / 0.01mm	Vertical Single-function	\$1,060.00	\$954.00

Applications

Machine table position

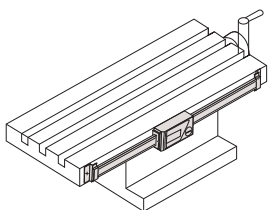

Drilling machine stroke position

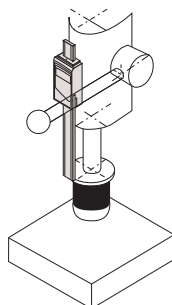

Focus setting on optical instruments

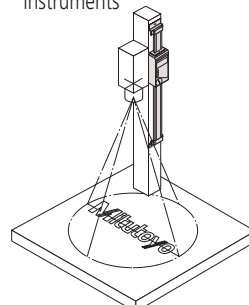

Special Applications

As a measurement jig for outdoor use (SD-G)

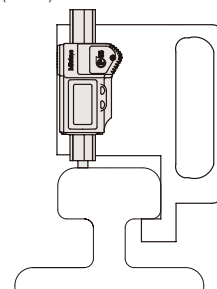

Detector head mechanism

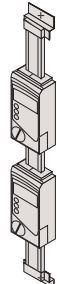

ALWAYS THERE. ALWAYS READY.

YOUR DEDICATED SUCCESS TEAM

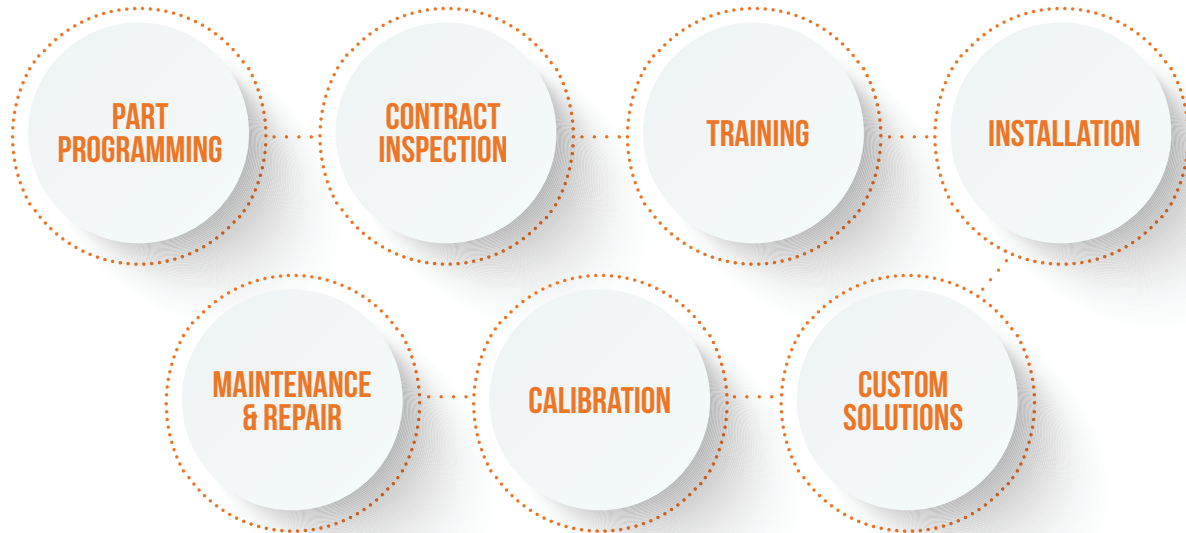

Courses Offered By The Mitutoyo Institute of Metrology

Online Courses:

EDU-G415 GD&T Fundamentals:

An introduction to GD&T procedures, ideal for entry-level professionals or those looking to sharpen their skills.

EDUB-201 Learning Package:

EDU-K205: Foundations of Dimensional Calibration,
EDU-K210: Calibration of Calipers, &
EDU-K220: Calibration of Outside Micrometers

Certified Credentials:

EDU-T110: Calibration of Micrometers & Calipers
Level 1 Credential - Online Exam
EDU-T220: Calibration of Micrometers & Calipers
Level 2 Credential -Exam in Person Aurora, IL.



*Scan the QR Code
to learn more about
the training we
have to offer*

Nationwide Support Infrastructure of Mitutoyo America

Headquarters: Aurora, Illinois

Metrology Services Center (ISO/IEC 17025 Accredited):

Aurora, Illinois; City of Industry, California; West Chester, Ohio

Services:

Aurora, Illinois: Calibration, Repair, Field Service, Contract Inspection

City of Industry: Calibration, Repair

West Chester, Ohio: Calibration, Contract Inspection, Contract Part Programming

M³ Solution Centers (Showrooms): Locations (8 in total):

Illinois, Washington, Texas, Ohio, Michigan, California, North Carolina, Massachusetts.

Note: At the M³ Solution Center, customers can not only view our products but also utilize the space to address their measurement challenges through demonstrations of our latest measuring instruments and technologies.

Total Number of Employees: Approximately 400

Mitutoyo products are sold through authorized distributors which can be found at my.mitutoyo.com/General/FindDistributor

My.Mitutoyo.com

Search for products, request a quote, take online metrology courses, and much more.

Note: All information regarding our products, and in particular the illustrations, drawings, dimensional and performance data contained in this printed matter as well as other technical data are to be regarded as approximate average values. We therefore reserve the right to make changes to the corresponding designs. The stated standards, similar technical regulations, descriptions and illustrations of the products were valid at the time of printing. In addition, the latest applicable version of our General Trading Conditions will apply. Only quotations submitted by ourselves may be regarded as definitive. Specifications are subject to change without notice. We reserve the right to change specifications and prices without notice. Not valid with any other offer or promotion, previous purchases. Please refer to terms and conditions for additional information. Domestic U.S. orders only.

Mitutoyo products are subject to US Export Administration Regulations (EAR). Re-export or relocation of our products may require prior approval by an appropriate governing authority.

Trademarks and Registrations

Designations used by companies to distinguish their products are often claimed as trademarks. In all instances where Mitutoyo America Corporation is aware of a claim, the product names appear in initial capital or all capital letters. The appropriate companies should be contacted for more complete trademark and registration information.

Mitutoyo

Mitutoyo America Corporation
965 Corporate Boulevard
Aurora, Illinois 60502
1-888-648-8869

0226 • Printed in USA • February 2026